

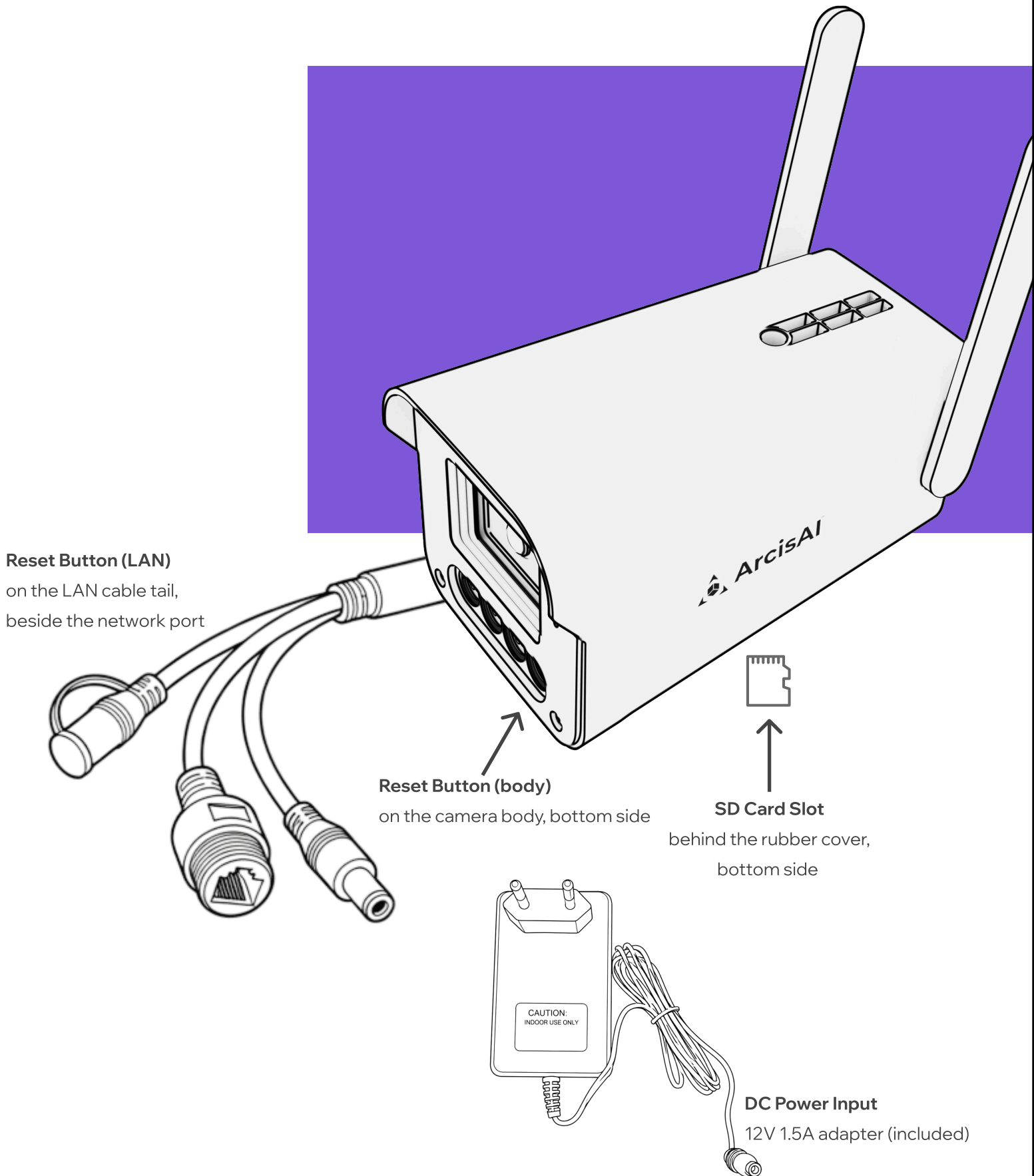

BULLET WI-FI USER MANUAL



Interface Description



Bullet Wi - Fi

What You Need

- Power Adapter 12V 1.5A (included)
- Smartphone with ArcisAI App
- 2.4GHz Wi-Fi connection
- Micro SD Card (optional)
- Screwdriver, Drill & Hammer

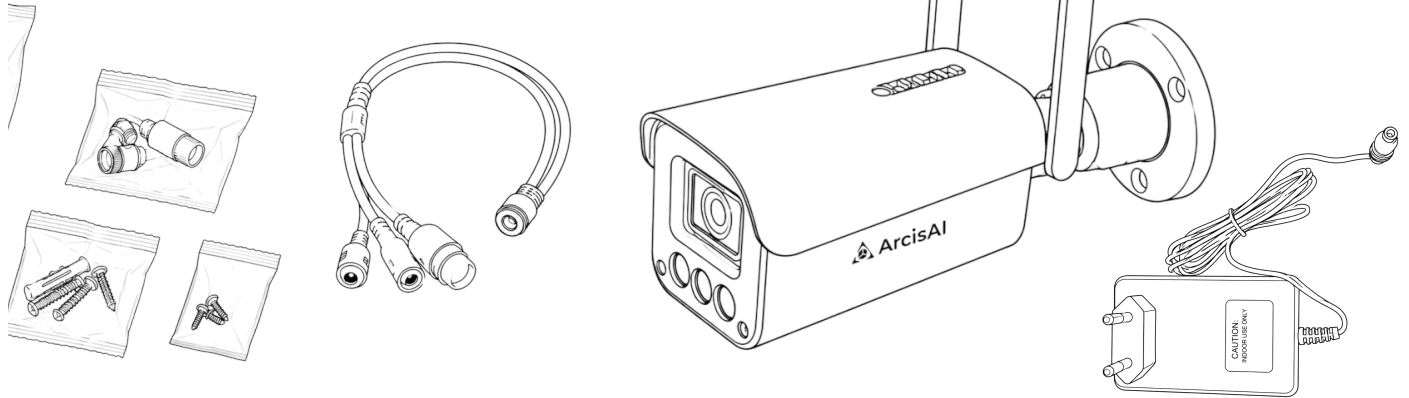

Installation & Placement

- Attach the camera stand to the camera using the provided screws.
- Mark the mounting points, then drill **four holes** at the marked locations.
- Insert the wall anchors using a hammer.
- 4 Secure the camera stand using four mounting screws.

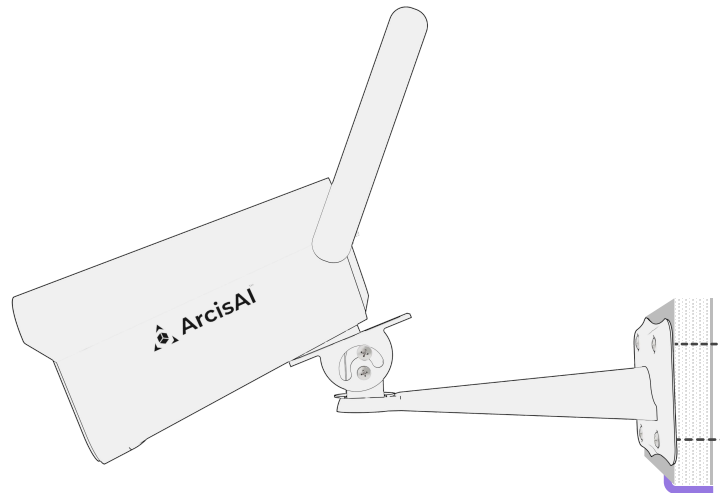

Software Installation

Scan the QR code below to download and install the ArcisAI app, then follow the in-app prompts to complete registration and log in.



Add Camera in ArcisAI App

After logging in, you land on the ArcisAI dashboard.

- Tap Add Camera from the dashboard.

Two ways to add a camera enter the Device ID manually, or scan the QR code.

Method 1

Enter Device ID

- Enter the Device ID of the camera (printed on the camera body / box, e.g. ATPL-200105-ARCIS).
- Enter the Camera Name you want to keep (e.g. Living Room, Front Hall).
- Tap + Add Camera to finish.

Method 2

Scan QR Code

- Tap the QR code icon on the right of the Device ID field.
- Point your phone at the QR code on the camera body / box. The Device ID fills in automatically.
- Enter the Camera Name you want to keep.
- Tap + Add Camera to finish.

Note: Make sure the Device ID is entered correctly - a wrong ID will not connect the camera.

Configure Wi-Fi

For Wi-Fi cameras, configure Wi-Fi in the app after adding the camera.

- Power on the camera and wait for it to start up completely.
- Press the Reset Button (on the camera body or on the LAN cable tail) and wait for the reset process to complete.
- Open the ArcisAI app and tap the camera, then go to Settings- Wi-Fi Config.
- Select your Wi-Fi network (SSID) from the list, or tap Enter manually to type it.
- Type your Wi-Fi password.
- Tap Generate QR.
- Double-press the Reset Button to enter Wi-Fi Configuration Mode.
- Hold the generated QR code 15-20 cm in front of the camera lens to scan it.
- Wait for the connection. A success message appears once the camera connects.

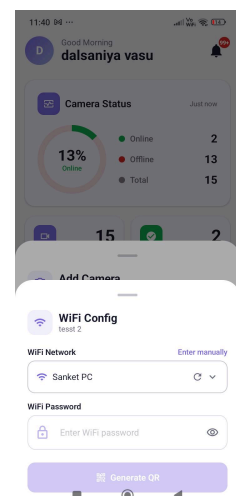
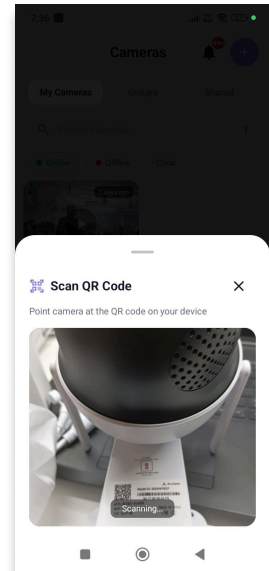
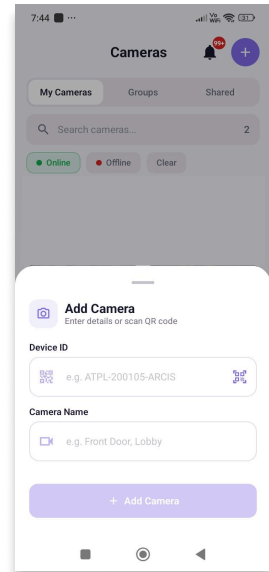

Bullet Wi - Fi

Controls



Reset Button (on the camera body and on the LAN cable)-Press once to reset. **Double-press** to enter Wi-Fi Configuration Mode for setup or re-pairing.



Two-Way Audio Listen and talk through the camera from the app (if supported).

WARNING



In case of fire or lightning, do not place the product in a damp or rainy location. Operate and maintain only according to this user manual.



Be careful when you see the Dangerous Voltage symbol, which may indicate a risk of serious electric shock.

Notice

- To ensure your safety, please read the user manual carefully before using the product.
- Please contact a professional if you need help to install and maintain the product.
- Working environment: temperature-10°C to +50°C, relative humidity under 85%.
- Do not exceed the standard range of temperature, humidity, and voltage suggested in this manual.

How to Install ArcisAI Cameras With NVR

Wi-Fi Camera with NVR

Wi-Fi cameras get internet through your Wi-Fi network and need a power adapter for power supply.

Step 1: Required Items

- NVR (Network Video Recorder)
- Wi-Fi IP Camera
- Power Adapter for Camera (mandatory)
- Ethernet (LAN) Cable
- Monitor (for NVR display)
- USB Mouse
- Router with Wi-Fi
- PC / Laptop (for ADCAMSCANNER tool)

Step 2: Connect Hardware

- Connect the NVR to the monitor using HDMI or VGA cable.
- Plug the USB mouse into the NVR.
- Connect the NVR to the router using a LAN cable.
- Power ON the NVR.

For the Camera:

- Connect the camera to the power adapter and plug it into a power socket.
- Connect the camera to the same Wi-Fi network as the NVR using the ArcisAI mobile app. (See the Wi-Fi Configuration section for full setup steps.)
- Wait for the voice prompt: "Wi-Fi connected".

Step 3: Install & Use ADCAMSCANNER Tool

To easily detect and configure cameras on the network, use ADCAMSCANNER.

Download the tool: [Click Here](#)

- Install and open ADCAMSCANNER on your PC.
- Click Scan / Refresh.
- All available devices will be listed (IP, MAC, Status, Firmware, etc.).
- Identify your camera using IP or MAC address.

Optional Configuration:

- Select the camera.
- Modify: IP Address, Netmask, Gateway, Port.
- Enter Username & Password.
- Click Apply.

Step 4: Install & Use ADCAMSCANNER Tool

- Turn ON the NVR and wait for boot.
- Set admin password when prompted.
- Configure Date & Time, Time Zone, and Language.

Step 5: Add Camera to NVR

- Go to Main Menu → Camera / Device Management.
- Click Search Device.
- The NVR will scan and show available IP cameras.
- Select your camera from the list and click Add.

HOW TO INSTALL ArcisAI CAMERAS with NVR

If the camera is not detected, use Manual Add and enter:

- IP Address (from ADCAMSCANNER)
- Username
- Password
- Port (default: 80)

Step 6: Configure Camera Settings

- Go to Camera Settings.
- Adjust Resolution, Frame Rate, and Bitrate.
- Enable Audio (if supported).

Step 8: Test Camera

- Check the live view on the monitor.
- Test controls (if applicable).
- Verify playback recording.

ArcisAI Eco-Series

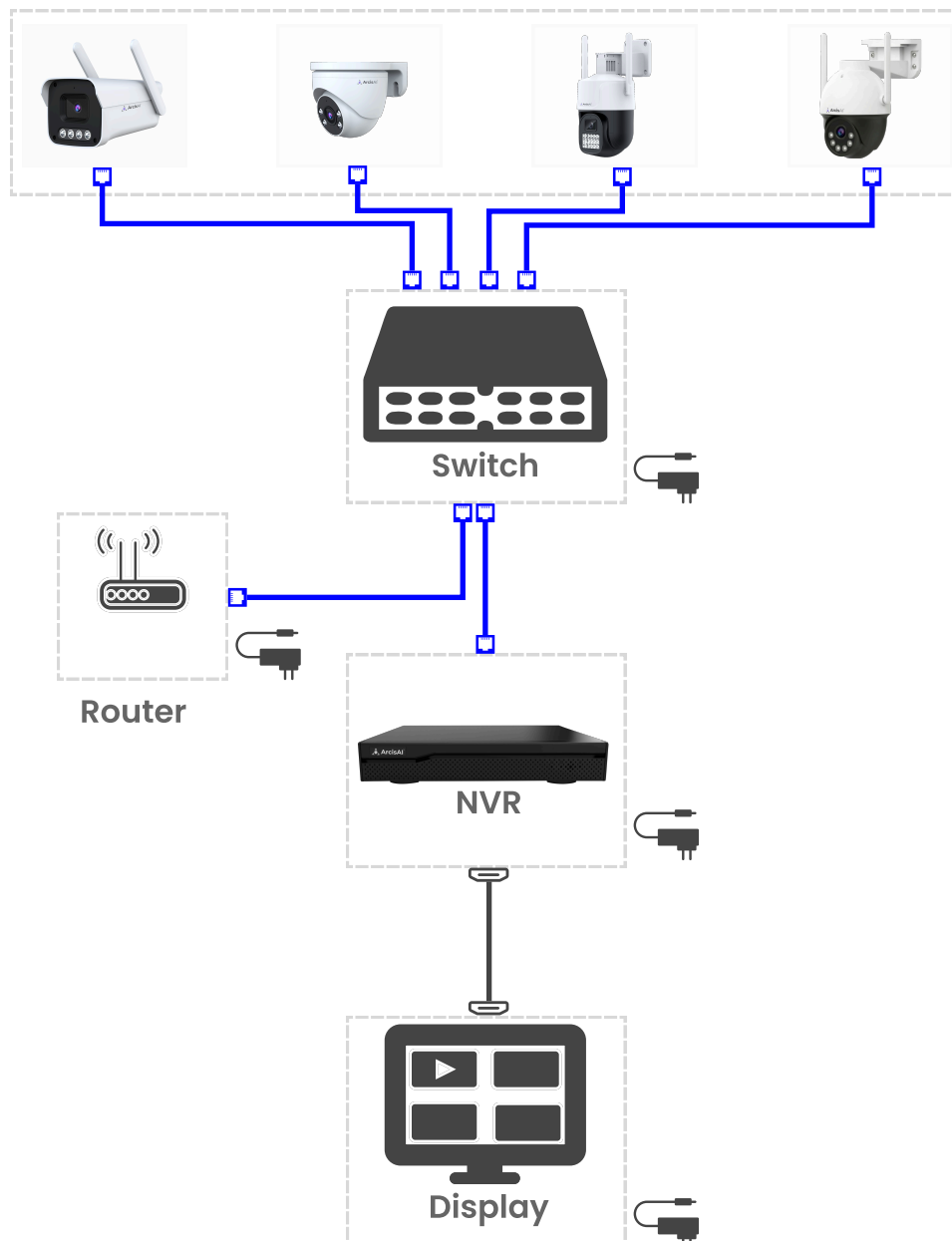

Signing In/ Registering

Signing In to Your ArcisAI Account

To securely access your ArcisAI account, follow the steps below:

Step 1: Open the App

- Open ArcisAI app

Step 2: Enter Your Credentials

- Input your registered email address or mobile number.
- Enter your secure password.

Step 3: Click “Sign In”

- Click the Sign In button.
- Upon successful verification, you will be redirected to your ArcisAI Dashboard.

Step 4: Sign In with Google (Optional)

If Google Authentication is enabled:

- Click **Sign In with Google**.
- You will be logged in automatically.

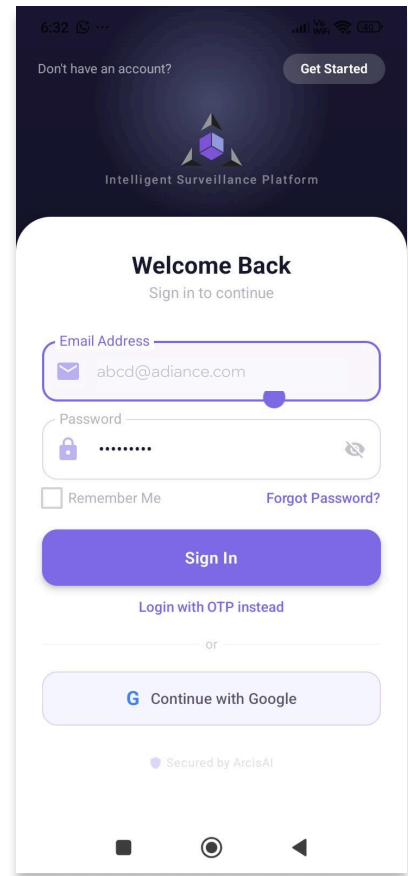

Registering a New ArcisAI Account

If you're new to ArcisAI, follow the steps below to create your account:

Step 1: Visit the ArcisAI Registration Page

- Launch your app

Step 2: Click “Get Started”

- Click on the “Get Started” button to access the registration form.

Step 3: Provide Required Details

- Enter a valid email address or mobile number.
- Create a strong password to secure your account.

Step 4: Verify Your Account

- A confirmation email or SMS will be sent to your registered contact.
- Click the verification link or enter the OTP (One-Time Password) to complete your registration.

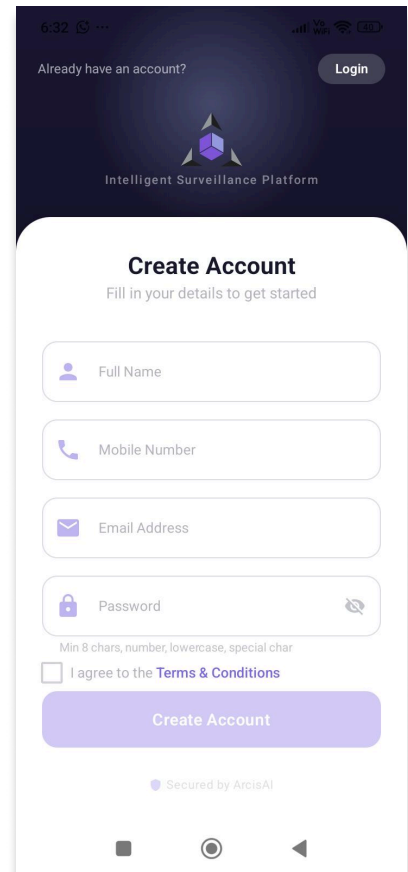

Adding a Camera

Adding a Camera to the Video Management System (VMS APP)

After logging in :

You will land on the ArcisAI VMS APP Dashboard. From there, tap the **Add Camera** option and follow the instructions below.

Adding a New Camera :

The Add Camera popup gives you two ways to add a camera: by entering the details manually or by scanning the QR code on the camera.

Option 1

Add Camera by Entering Details

Step 1: Enter the Device ID

- Type the Device ID of your camera in the Device ID field.
- The Device ID is printed on the camera body or on the box.
- Example format: ATPL-200105-ARCIS

Step 2: Enter the Camera Name

- Type a name for your camera in the Camera Name field.
- Use any name that is easy to recognise (for example, Front Door, Lobby, Main Gate).
- This name will be shown on the dashboard and in the camera list.

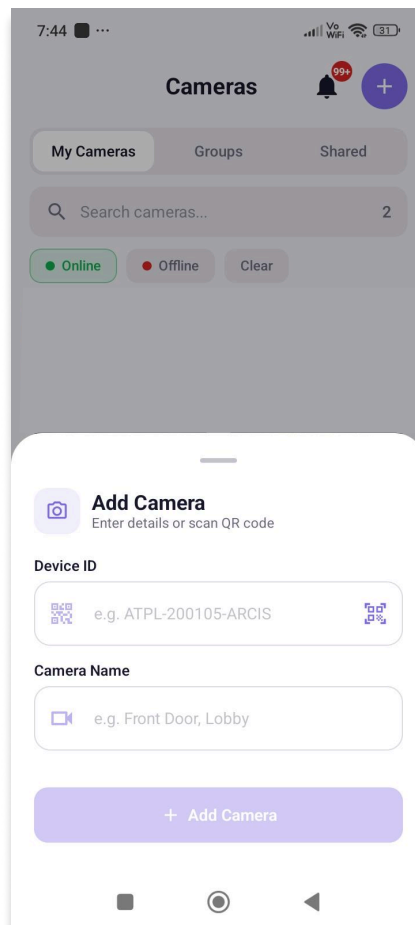

Adding a Camera

Step 3: Tap "Add Camera"

After filling both fields, tap the **+ Add Camera** button at the bottom.

The camera will be added to your account and will start showing on the dashboard.

Step 4: Complete the Camera Setup

Based on your camera type, follow Wi-fi Camera Setup Method explained on Page 3.

Option 2

Add Camera by Scanning QR Code

- Tap the QR code icon on the right side of the Device ID field.
- The camera scanner will open.
- Point your phone at the QR code printed on the camera body or box.
- Once the QR code is scanned, the Device ID will fill in automatically.
- Enter the Camera Name and tap **+ Add Camera** to finish.
- For full setup, follow the Wi-fi Camera Setup Method on Page [3].

Note:

- Make sure the Device ID (ATPL-200105-ARCIS) is entered correctly. A wrong ID will not connect the camera.
- For Wi-Fi cameras, you must first configure Wi-Fi on the camera using the mobile app before adding it to the VMS APP. See the Camera Setup Methods section on Page [3].

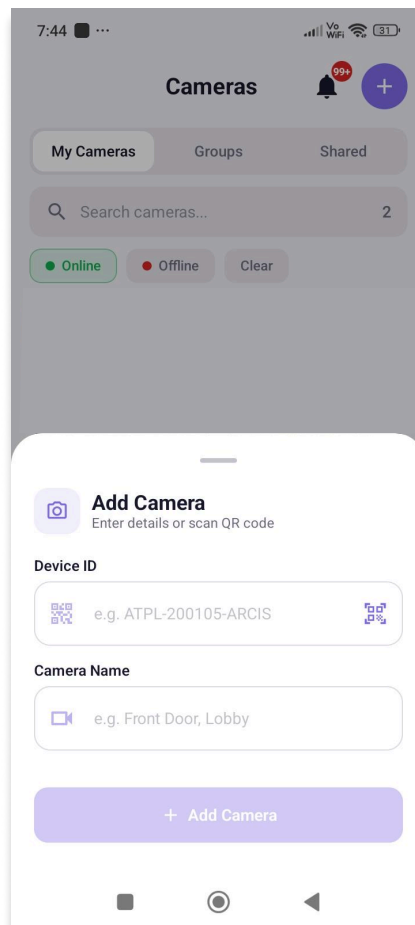

Dashboard Overview

The ArcisAI VMS APP Dashboard is the main screen of the app. It gives you a single place to check the status of all your cameras, view recent alerts, and use quick shortcuts to important features. When you log in, the dashboard welcomes you with a personal greeting and your account name.

Profile Icon & Greeting:

The top-left corner shows your profile initial along with a greeting based on the time of day (for example, "Good Afternoon") and your registered account name.

Notification Bell

The top-right corner shows a bell icon with the number of unread alerts. Tap the bell to open the Notifications screen.

Notifications

The Notifications screen shows all alerts received from your cameras in one place. To open it, tap the **Notification Bell** from the top-right corner of any screen.

Back Arrow (←):

Return to the previous screen.

Unread Count:

Shows the total number of unread alerts at the top.

Mark All Read:

Tap to mark all notifications as read.

Mute / Unmute Notifications:

Tap the notification bell icon to mute or unmute notifications.

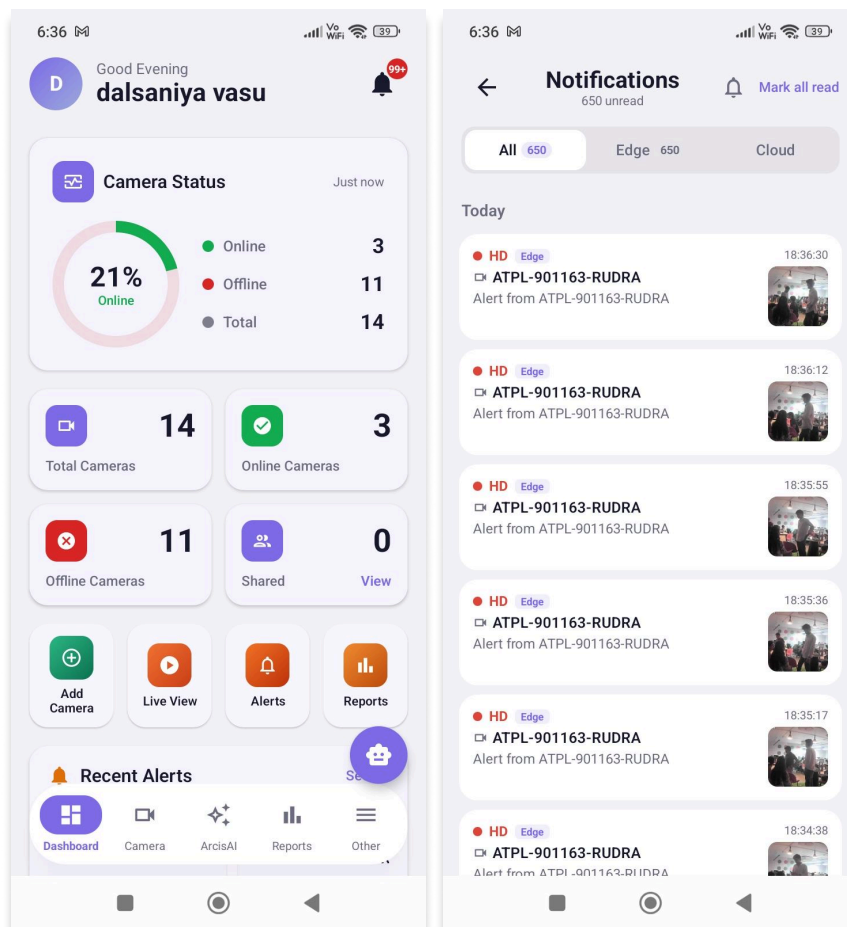

Dashboard Overview

Notification Tabs

Three tabs sort notifications by source:

All: All notifications from every camera.

Edge: Alerts detected by the camera's built-in Edge AI.

Cloud: Alerts processed through cloud AI analytics.

Notification Card

Each notification card shows the alert type (for example, HD, FD), source (Edge or Cloud), camera name, time, and a snapshot thumbnail. Tap any notification to open the full event details.

Camera Status Overview

The Camera Status panel shows the overall health of your camera network in real time using a circular chart.

Online Percentage:

The centre of the chart shows the percentage of cameras that are currently active and streaming.

Online:

The number of cameras that are live and working (shown with a green dot).

Offline: The number of cameras that are disconnected or not transmitting (shown with a red dot).

Total: The total number of cameras registered under your account (shown with a grey dot).

Last Updated: A timestamp on the top-right of the panel shows when the status was last refreshed (for example, "Just now").

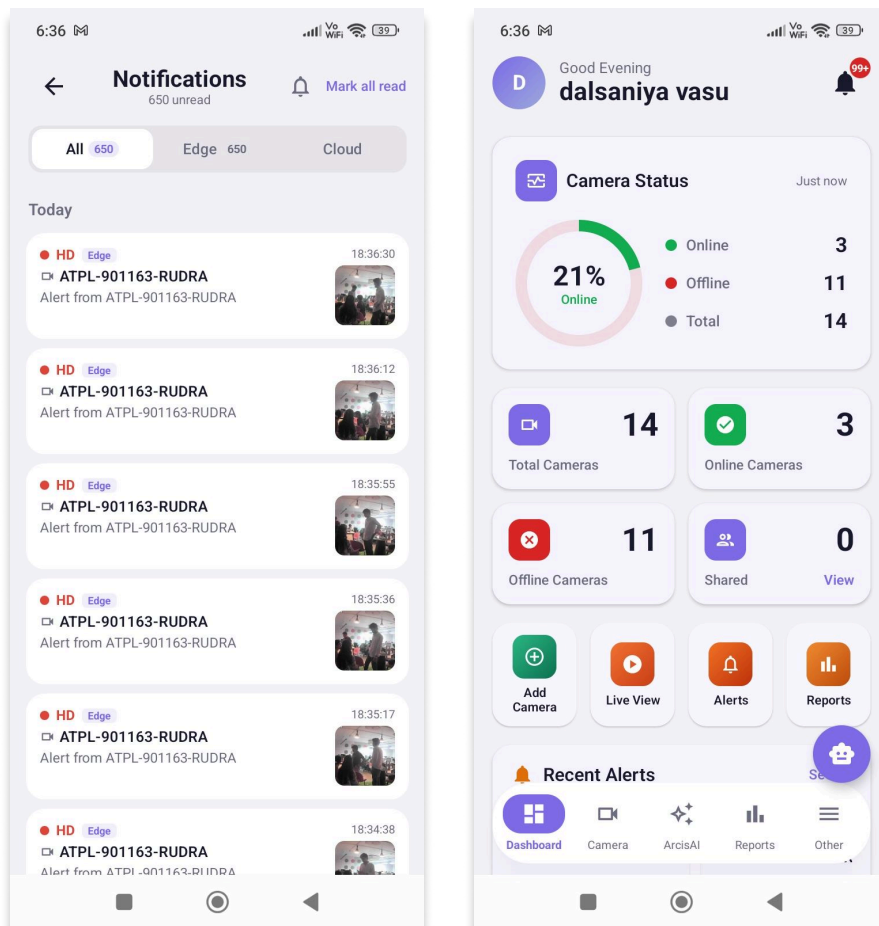

Dashboard Overview

Key Metrics Tiles

Below the Camera Status panel, four quick-glance tiles show a summary of your camera ecosystem.

Total Cameras: Shows the total number of cameras registered in the VMS APP.

Online Cameras: Shows the number of cameras that are active and streaming. Visual Indicator: Green

Offline Cameras: Shows the number of cameras that are disconnected or not transmitting. Visual Indicator: Red

Shared Cameras: Shows the number of cameras shared with other users or accounts for collaborative access. Tap View to see the shared camera details. Visual Indicator: Purple

Quick Access Shortcuts

The dashboard provides one-tap shortcuts to the most-used features of the app.

Add Camera: Opens the Add Camera popup to register a new camera. (See the "Adding a Camera to the VMS APP " section for full details.)

Live View: Opens the live feed of your connected cameras.

Alerts: Opens the Alerts section to view all triggered notifications.

Reports: Opens the report interface to generate and download event-based reports.

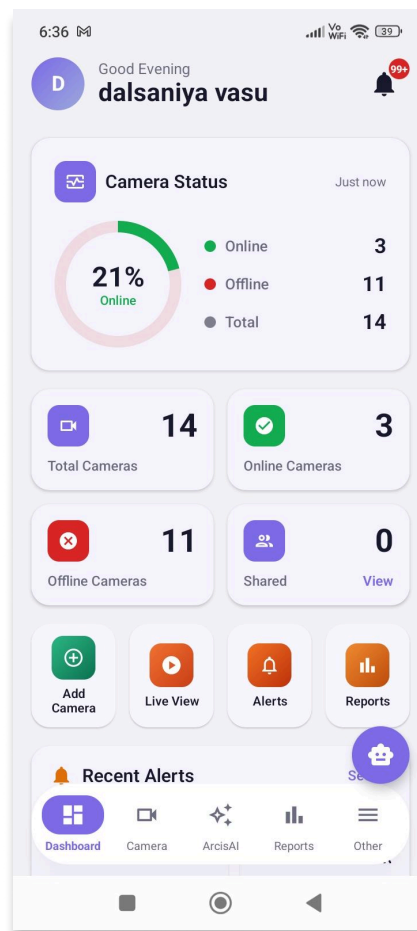

Dashboard Overview

Recent Alerts

The Recent Alerts section shows the latest notifications received from your cameras, so you can check important activity at a glance.

- Each alert card shows the camera name, alert type (for example, HD), and time elapsed since the alert was triggered (for example, "18m ago").
- Tap **See All** on the right side of the section to open the full list of alerts.

AI Coverage

The AI Coverage panel shows how many of your cameras have ArcisGPT AI analysis turned on.

- It shows the number of AI-enabled cameras out of the total cameras (for example, "1 of 12 cameras").
- A progress bar shows the percentage of cameras using AI features.
- This helps you quickly see which cameras can still be upgraded with AI-based analytics.

ArcisGPT Banner

The dashboard also shows a promotional banner that highlights the AI features available on ArcisAI:

"Unlock AI-Powered Surveillance: Tailored Plans for Every Need"

The banner shows the main highlights of ArcisGPT:

Action Tracking: Tracks human or object actions in real time.

Object Recognition: Identifies and labels objects in the camera view.

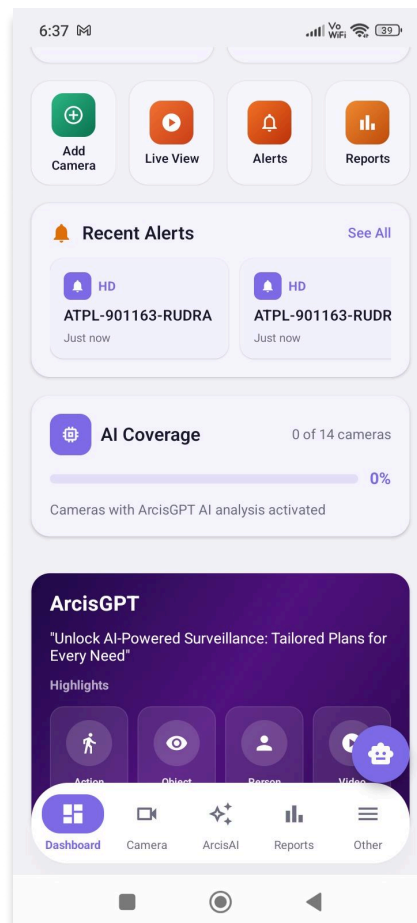

Dashboard Overview

Person Recognition: Detects and recognises people using AI.

Video Summary: Creates short AI-generated summaries of recorded videos.

ArcisAI Support Assistant

The ArcisAI Assistant is a chat button shown on the dashboard. You can use it to ask any question or get help with your cameras, alerts, or account.

- Tap the purple robot icon on the bottom-right side of the screen to open the assistant.
- You can type any question or problem related to your cameras, alerts, or account, and the assistant will reply with the right answer or guide you to the correct option.
- The assistant also shows a list of default questions you can choose from, so you don't need to type your question every time. Just tap a suggested question to get the answer instantly.
- Use it for quick help, troubleshooting, feature-related questions, and AI-related queries.

Bottom Navigation Bar

The bottom navigation bar gives quick access to the main sections of the app. It is shown at the bottom of every screen.

- **Dashboard:** Opens the main dashboard screen (the current page).
- **Camera:** Opens the live and recorded camera feeds.
- **ArcisAI:** Opens the ArcisGPT AI assistant for AI-based questions and insights.
- **Reports:** Opens the report interface to generate and view event reports.
- **Other:** Opens additional settings and account options.

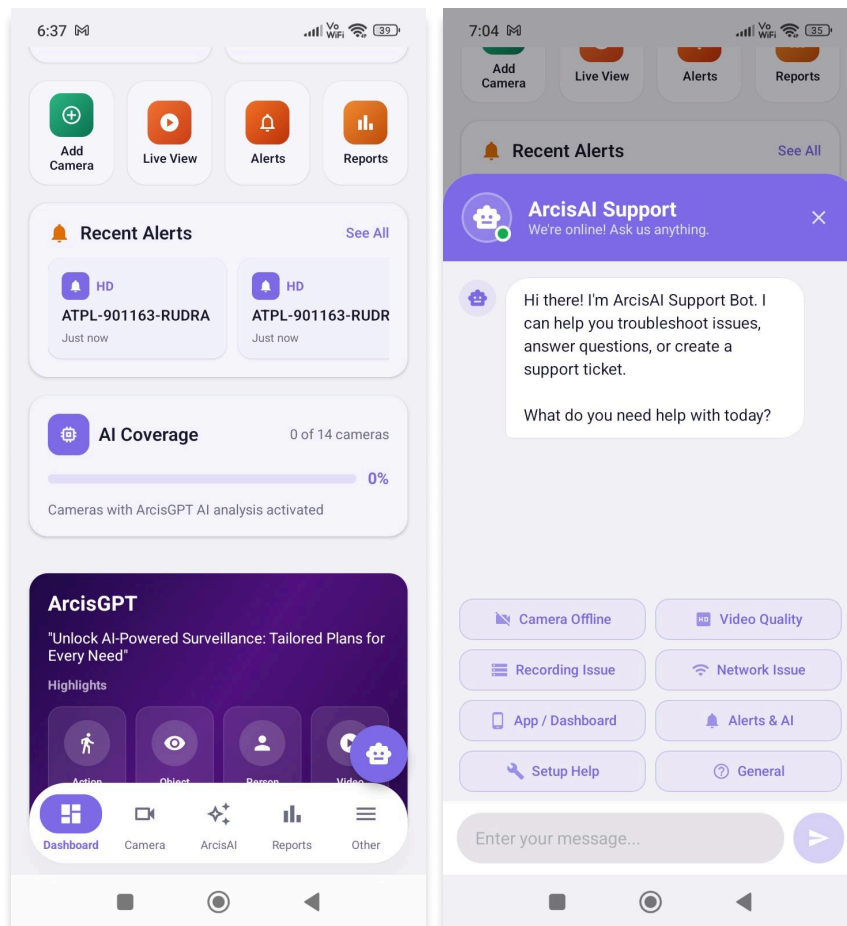

Camera Section

The Camera section is where you can view all your cameras, search for a specific camera, and open the live view of any camera. To open it, tap **Camera** on the bottom navigation bar.

Header

Camera Title: Shown at the top centre.

Add Camera (+) Button: Tap the purple + icon to open the Add Camera popup directly from this screen.

Camera Tabs

Three tabs help you organise your cameras:

- **My Cameras:** All cameras owned and managed by your account.
- **Groups:** Cameras organised into custom groups for easy access (for example, by location or floor).
- **Shared:** Cameras shared with you by other users.

Search and Filter

Three tabs help you organise your cameras:

- **Search Bar:** Type a camera name to find it quickly. The number on the right side of the search bar shows the total count of cameras in the current view.
- **Online Filter:** Tap Online to show only cameras that are currently live and streaming.
- **Offline Filter:** Tap Offline to show only cameras that are disconnected.
- **Clear:** Tap Clear to remove all applied filters and show the full camera list.

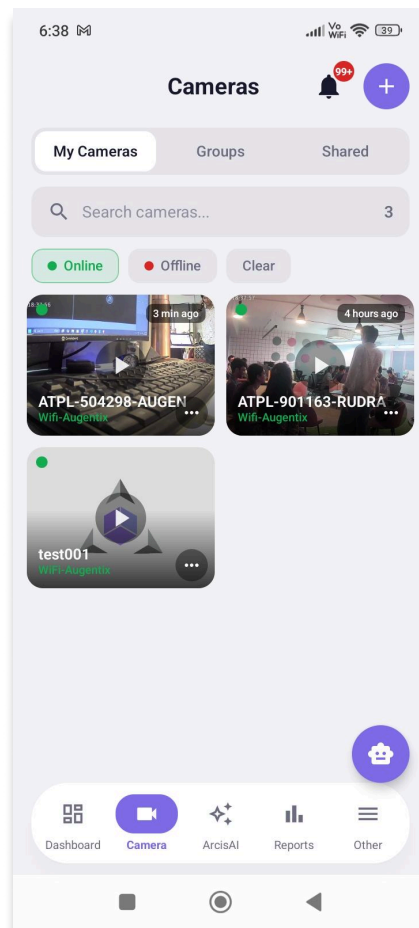

Camera Section

Camera Card

Each camera in the list is shown as a card with a live preview and key details.

- **Live Preview:** The latest snapshot or live preview of the camera feed.
- **Status Dot:** A small dot on the top-left — green for online, red for offline.
- **Last Activity Time:** Shows when the camera was last active (for example, "19 hours ago").
- **Camera Name:** The name you have given to the camera.
- **Camera Model:** Shown below the camera name (for example, Wifi-Augentix).
- **Play Button:** Tap the play icon in the centre to open the live view of that camera.
- **Three-Dot Menu :** Tap to open the camera options menu.

Camera Options Menu (Three-Dot Menu)

Tap the three-dot menu (:) on any camera card to open the options menu. The popup shows the camera name and its status (Online or Offline) at the top, with the following options:

Rename Device: Change the camera's display name. Enter the new name and tap Save.

Wifi Config : Update the camera's Wi-Fi settings (for Wi-Fi cameras only). Select the **Wi-Fi network**, enter the password, and tap Generate QR. Hold the QR code in front of the camera lens at a distance of 15–20 cm. You will hear **"Wi-Fi connected"** when the camera connects successfully.

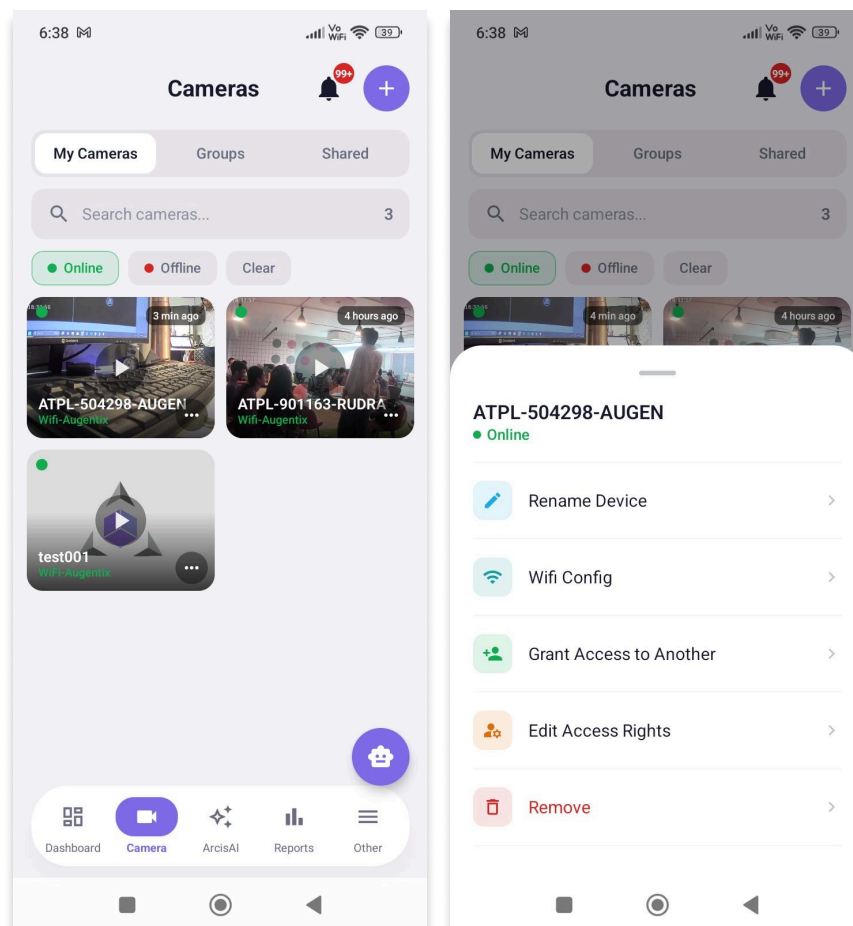

Camera Section

Grant Access to Another: If you want to give access to someone, enter their email ID and tap Share Access. The person will be able to view this camera feed from their ArcisAI account under the Shared tab.

Edit Access Rights: View and manage users who already have access to this camera. You can change permissions or remove their access. If no one has access yet, the screen will show "No users have access to this camera".

Remove: Delete the camera from your account. Tap **Remove** and confirm.

Camera Live View

When you tap a camera card, the Camera View screen opens. This screen shows the live feed of the selected camera along with playback and control options.

Header

- **Back Arrow (←):** Return to the Camera list.
- **Camera View Title:** Shown at the top centre.
- **Settings Icon (⚙️):** Opens the Camera Settings panel.

Breadcrumb

Below the header, a breadcrumb shows your current path (for example, Cameras > ATPL-504298-AUGEN) along with a green Live indicator.

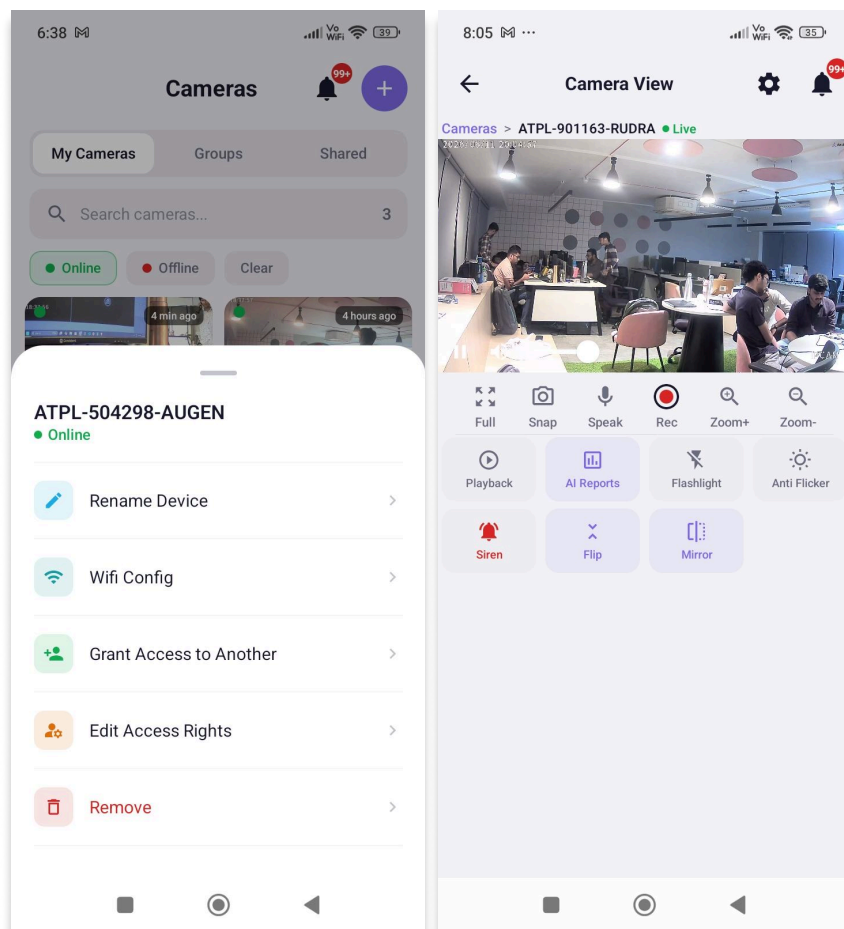

Camera Section

Live Video Feed

- The main area shows the live video feed in real time with a timestamp on the top-left.
- A volume slider at the bottom-left of the video controls the audio level.

Live View Controls

Below the live feed, control buttons are available to interact with the camera.

Playback and Recording Controls

- **Full-Screen Mode:** Expand the video feed to full screen for a clearer view.
- **Snap:** Capture a screenshot of the current live feed.
- **Speak (Push-to-Talk):** Activate the microphone to talk through the camera for two-way audio communication.
- **Rec (Start & Stop Recording):** Manually start or stop video recording as needed.
Note: Recording can only be started during a live feed.
- **Zoom In (+):** Magnify specific sections of the video feed for closer inspection.
- **Zoom Out (-):** Reduce the zoom level for a broader field of view.

Smart Controls

- **Playback:** Open recorded video footage from cloud or SD card storage.
- **AI Reports:** Turn AI-based reports and insights on or off for the selected camera.

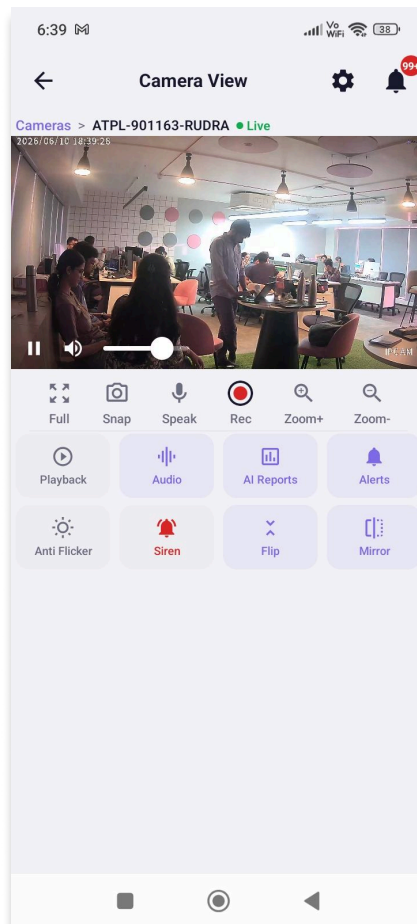

Camera Section

Camera Adjustment Controls

- **Anti Flicker:** Reduce flicker caused by certain lighting conditions.
- **Siren Control:** Trigger an audible alert from the camera to deter unwanted activity.
- **Flip:** Vertically flip the camera image.
- **Mirror:** Horizontally mirror the video feed.

PTZ Camera Controls (PTZ Models Only)

The following options are available only on PTZ cameras:

- **PTZ:** Open pan, tilt, and zoom controls to move the camera.
- **Tracking:** Enable automatic human tracking. The camera will follow human movement.
- **Patrol (Cruise Mode):** The camera moves between positions automatically.
- **Preset:** Save and manage preset camera positions for quick access.

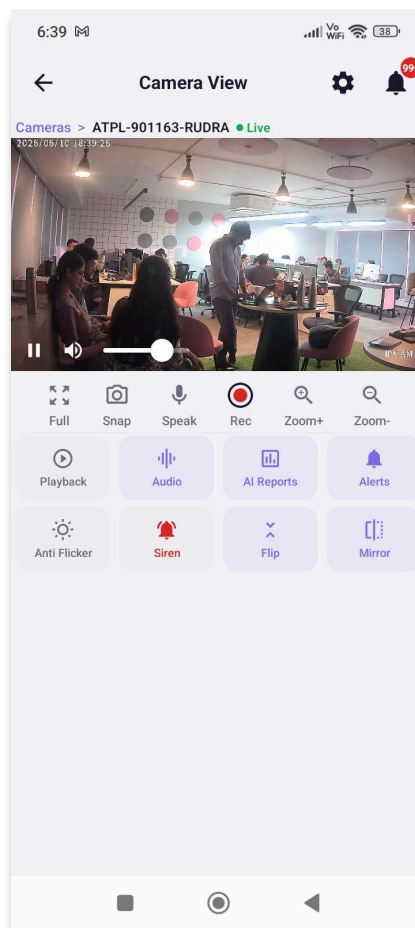

Camera Settings

To open Camera Settings, tap the Settings icon on the Camera View screen.

The settings panel shows the camera name and status at the top, and is divided into four tabs:

- **General:** Basic camera info and main controls.
- **Media:** Image and display adjustments.
- **AI Settings:** Smart detection and AI features.
- **Diagnostics:** Camera health and network details.
- **Credentials:** Manage camera login username and password.

General Settings

Device Info

- **Camera Name:** Display name of the camera.
- **Camera Model:** Camera model type (for example, Wifi-Augentix).
- **Device ID:** Unique ID of the camera (for example, ATPL-504298-AUGEN).
- **Firmware:** Current firmware version (for example, 0.12.3).

Controls

- **Device Volume:** Adjust the speaker volume of the camera.
- **Audio (Adjust Camera Sound):** Turn the camera microphone on or off, and control audio volume.

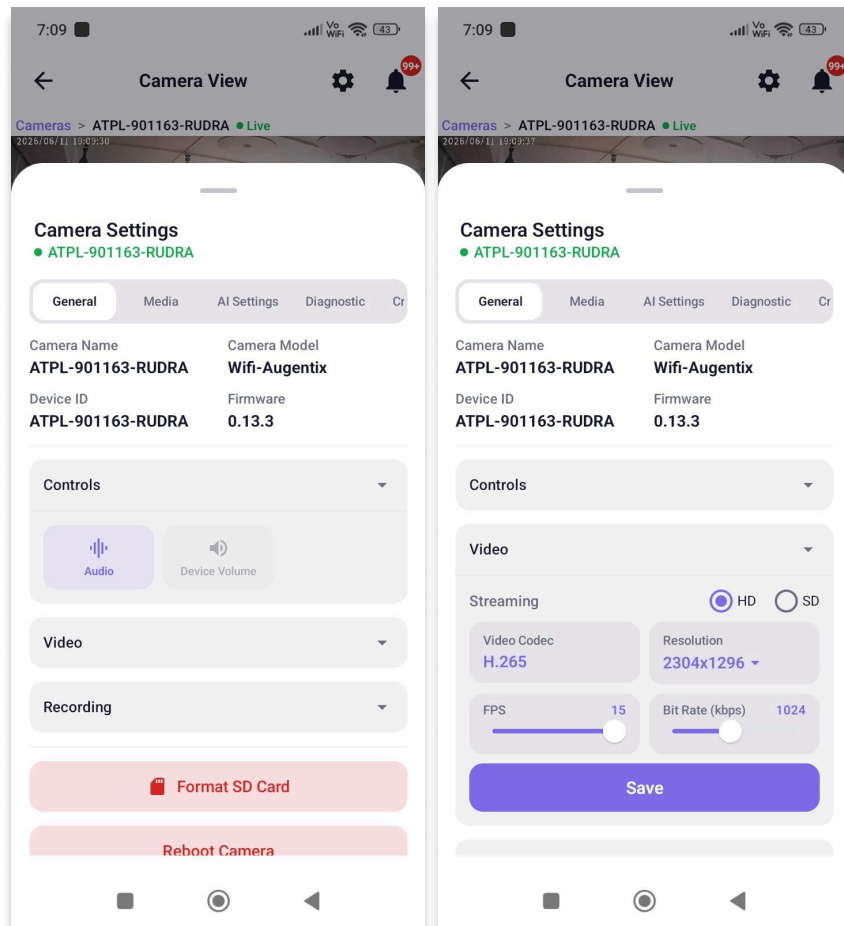

Camera Settings

Video Settings

Expand the Video section under General Settings to adjust streaming options.

- **Streaming:** Choose between HD (High Definition) or SD (Standard Definition) mode.
- **Video Codec:** Shows the codec used by the camera (for example, H.265).
- **Resolution:** Select the video resolution from the dropdown (for example, 2304x1296).
- **FPS:** Set the frame rate using the slider (for example, 15).
- **Bit Rate (kbps):** Set the data transmission rate using the slider (for example, 1024).
- Tap Save to apply changes.

Recording

Expand the Recording section under General Settings.

- **Motion Recording:** Turn on motion-based recording. The camera will record only when motion is detected, saving storage space. Note: Works only when an SD card is inserted in the camera.

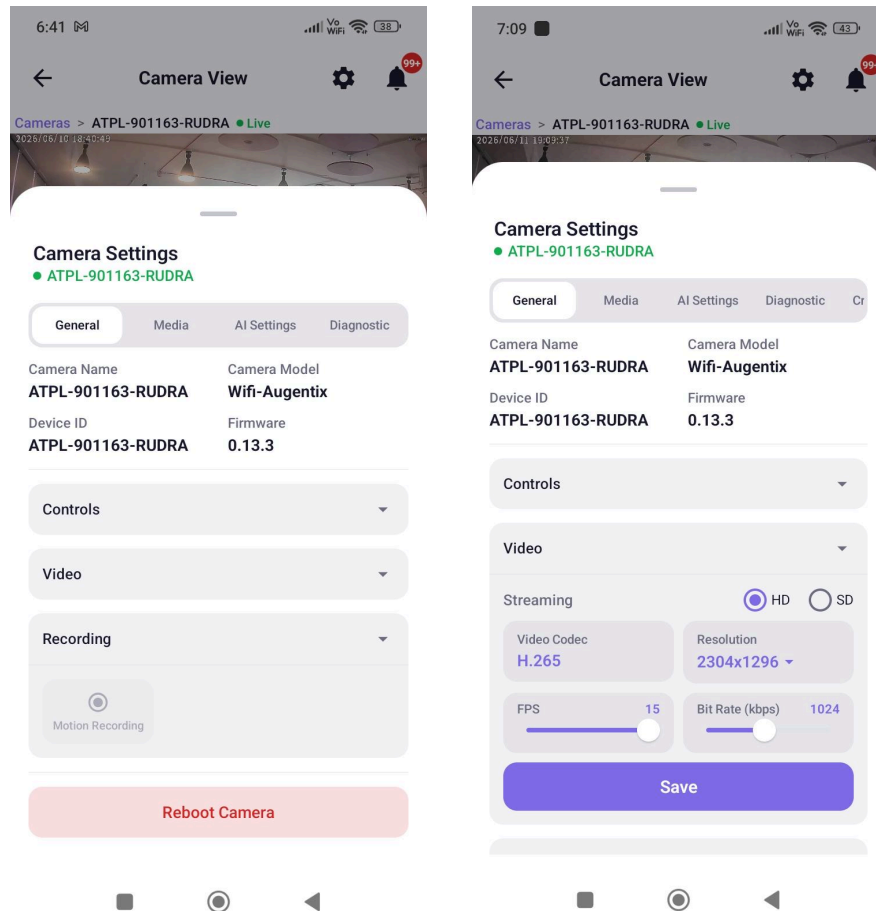

Camera Settings

Format SD Card

- Tap the Format SD Card button under the Recording section to open the SD Card popup. From here, you can view the SD card status and format it if needed.
- The popup shows:
 - **SD Card Status:** Shows the current health of the SD card (for example, ok).
 - **Used Percentage:** A circular chart shows how much of the SD card is used (for example, 92% Used).
 - **Used:** Total space used on the SD card (for example, 6.9 GB).
 - **Free:** Available space remaining (for example, 534 MB).
 - **Total:** Total capacity of the SD card (for example, 7.4 GB).

To format the SD card:

- Tap Format to erase all recordings on the SD card.
- Tap Cancel to close the popup without formatting.
- Warning: Formatting will permanently erase all recordings on the SD card. This action cannot be undone.

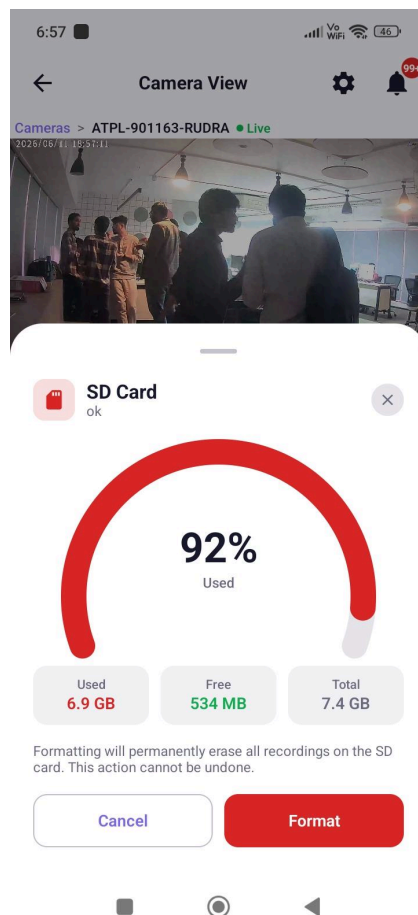

Camera Settings

Reboot Camera

Tap the Reboot Camera button at the bottom to restart the camera remotely.

Media Settings

IR Mode

Set the night vision mode of the camera. Tap the IR Mode dropdown and choose one of the following options:

- **IR Mode:** Standard infrared night vision.
- **Light Mode:** Uses the camera's built-in light.
- **Smart Mode:** Camera automatically switches between IR and light based on the surroundings.
- **Daylight Mode:** Forces the camera to use daylight settings.
- **Night Mode:** Forces the camera to use night settings.

Tap **Save** to apply changes.

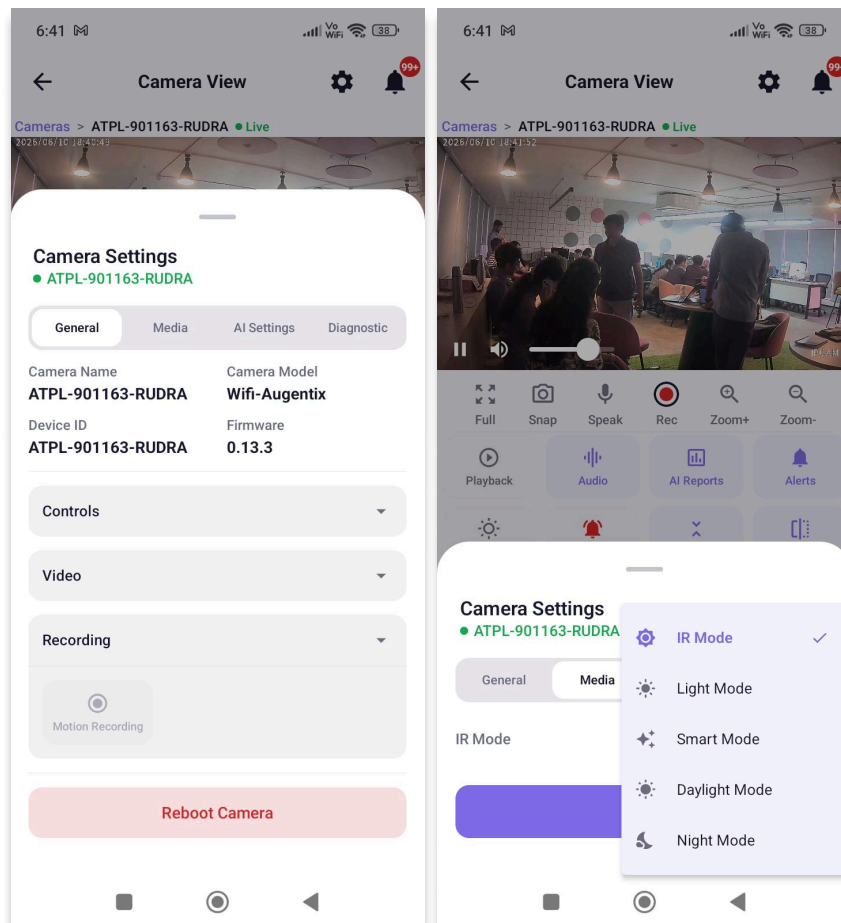

Camera Settings

AI Settings

ArcisAI Eco Series cameras come with built-in Edge AI features for smart surveillance. The AI Settings tab gives you control over these detection features.

AI Detection Models

The Eco Series supports three Edge AI detection features:

- **Motion Detection**
- **Human Detection**
- **Tamper Detection**

Note: Motion Detection must be enabled first to use Human Detection and Tamper Detection.

Motion Detection

Tap **Motion** on the AI Settings screen to open the Motion Detection popup.

- **Enable:** Turn motion detection on or off.
- **Alarm:** Turn on a sound alert when motion is detected.
- **Light Alert:** Turn on a light alert when motion is detected.
- **Sensitivity:** Adjust the sensitivity level using the slider (for example, 90%). Higher sensitivity detects smaller movements; lower sensitivity reduces false alerts.

Tap **Save** to apply your settings.

Use higher sensitivity for indoor environments and lower sensitivity for outdoor or high-traffic areas.

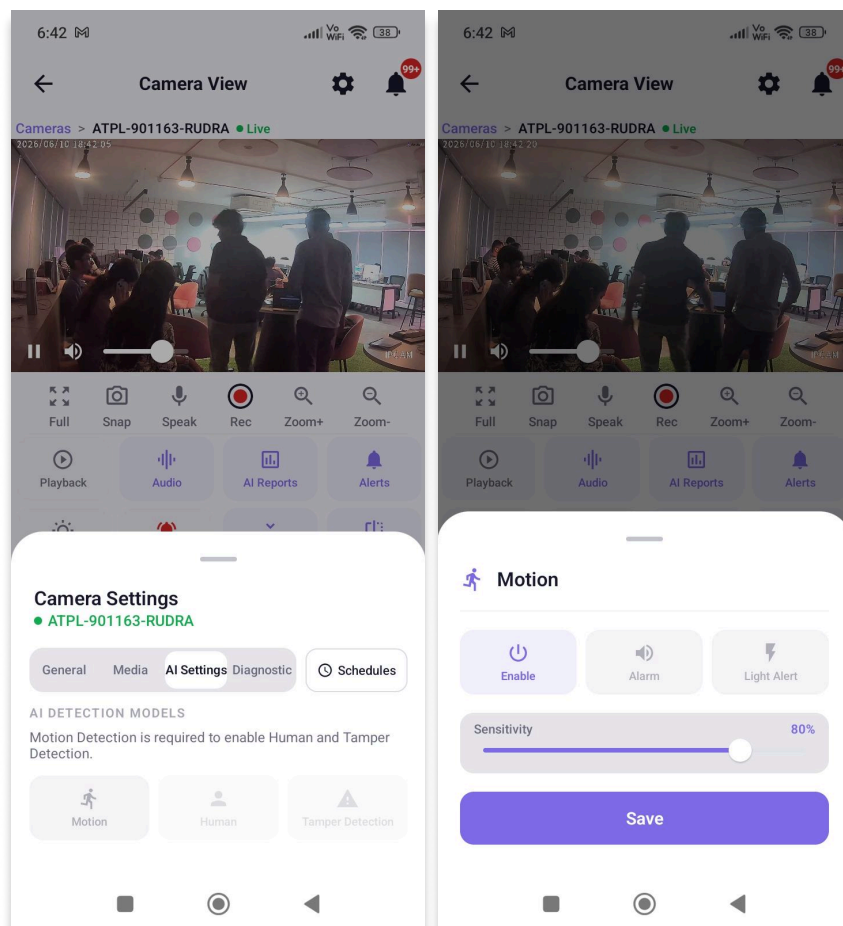

Camera Settings

Human Detection

Tap **Human** on the AI Settings screen to open the Human Detection popup.

- **Enable:** Turn human detection on or off.
- **Alarm:** Turn on a sound alert when a human is detected.
- **Light Alert:** Turn on a light alert when a human is detected.
- **Sensitivity:** Adjust the sensitivity level using the slider (for example, 5/10).

Tap **Save** to apply your settings.

Human Detection helps reduce false alerts by detecting only humans, not pets or vehicles.

Tamper Detection

Tap **Tamper Detection** on the AI Settings screen to open the Tamper Detection popup.

Tamper Detection alerts you if someone tries to block, move, or tamper with the camera or SD card.

- **IPC Detect:** Enable detection for any tampering with the camera (for example, blocking the lens or moving the camera).
- **TF Detect:** Enable detection for any tampering with the SD card (for example, removal or damage).

Tap **Save** to apply your settings.

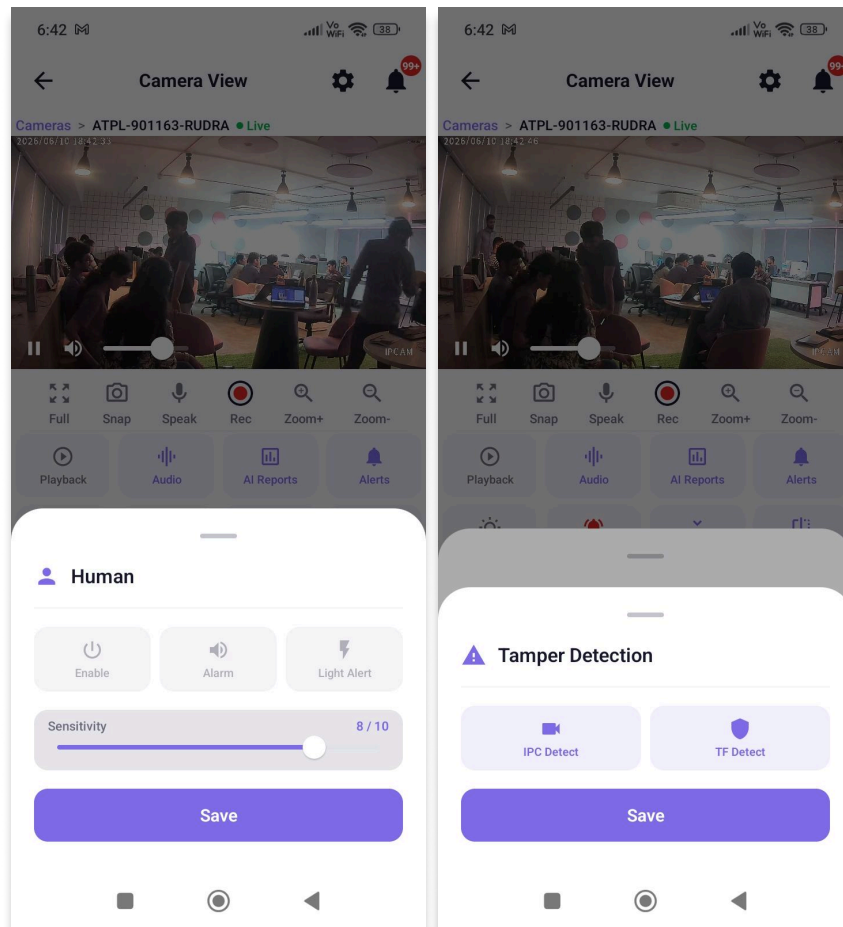

Camera Settings

Schedules

Tap **Schedules** on the AI Settings screen to create time-based AI alert rules for specific detections.

How to Configure

- **Step 1:** Tap **Schedule**.
- **Step 2:** Tap **Add Schedule**.
- **Name:** Enter a custom alert name (for example, Night Watch).
- **Detection:** Select the AI feature (Motion, Human, or Tamper Detection).
- **Start Time:** Set the time when the alert should begin.
- **End Time:** Set the time when the alert should stop.
- **Select Days:** Choose the days for the schedule. If no days are selected, the schedule will run every day.

Tap **Save** to apply your settings.

Diagnostic

The Diagnostic tab shows the health and network status of your camera, useful for troubleshooting

Wi-Fi Details

- **Wi-Fi Name:** The Wi-Fi network the camera is connected to (for example, WiFi_QC).
- **Wi-Fi Signal:** Current signal strength (for example, Excellent).
- **RSSI:** Signal strength value in dBm (for example, -37 dBm).
- **IP Address:** Current IP address of the camera (for example, 192.168.12.202).

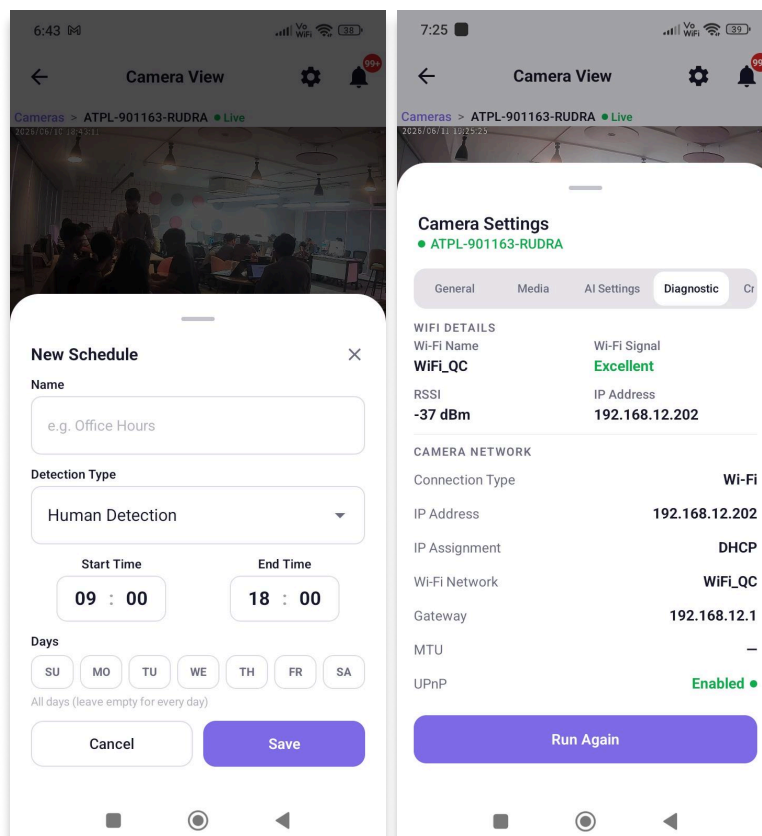

Camera Settings

Camera Network

- **Connection Type:** Wi-Fi, PoE, or 4G.
- **IP Address:** Current IP address of the camera.
- **IP Assignment:** STATIC or DHCP.
- **Wi-Fi Network:** Connected Wi-Fi name (for Wi-Fi cameras).
- **Gateway:** Network gateway address.
- **MTU:** Maximum Transmission Unit value.
- **UPnP:** Shows whether UPnP is Enabled or Disabled.

Run Again

Tap Run Again to refresh the diagnostic test. The last tested time is shown below the button.

Credential

- The Credential tab lets you manage the camera's login username and password for added security.
- **Username:** Shows the current camera username (for example, admin).
- **Current Password:** Enter your current camera password. Tap the eye icon to show or hide it.
- **New Password:** Enter a new password for the camera.
- **Confirm New Password:** Re-enter the new password to confirm.
- Tap Save Credentials to apply the changes.

Note: Make sure to remember your new credentials. You will need them for future access and configurations.

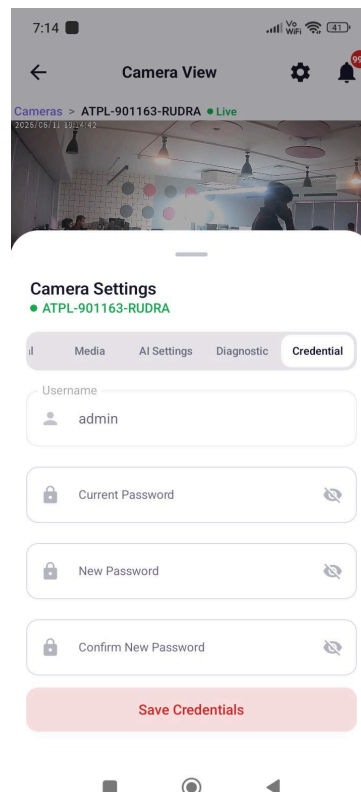
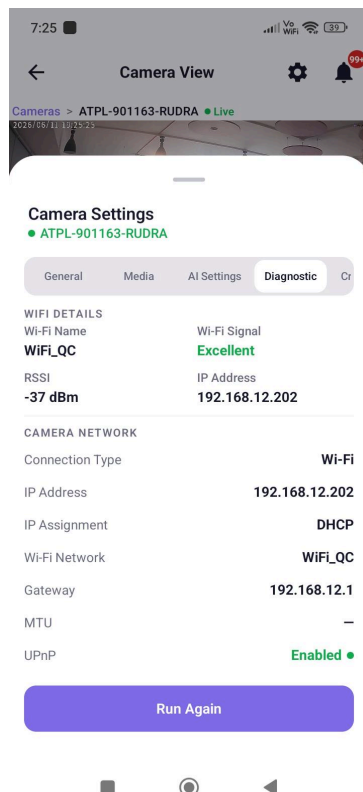

ArcisAI Assistant

ArcisAI Assistant is what makes ArcisAI unique — a smart AI helper similar to ChatGPT, built right into your surveillance system. You can ask anything about your cameras, events, and analytics in plain language. To open it, tap **ArcisAI** on the bottom navigation bar.

Four Main Features

- **Action Tracking:** Tracks human or object actions in real time.
- **Object Recognition:** Identifies and labels objects in the camera view.
- **Person Recognition:** Detects and recognises people using AI.
- **Video Summary:** Creates short AI-generated summaries of recorded videos.

Try Asking

The screen shows a list of default questions you can tap to get instant answers (for example, "Give me a summary of all cameras", "Is there any unusual activity?").

Ask ArcisAI Input Bar

At the bottom, an input bar lets you type or speak your question. Tap the microphone icon to ask by voice, or the speaker icon to listen to the reply.

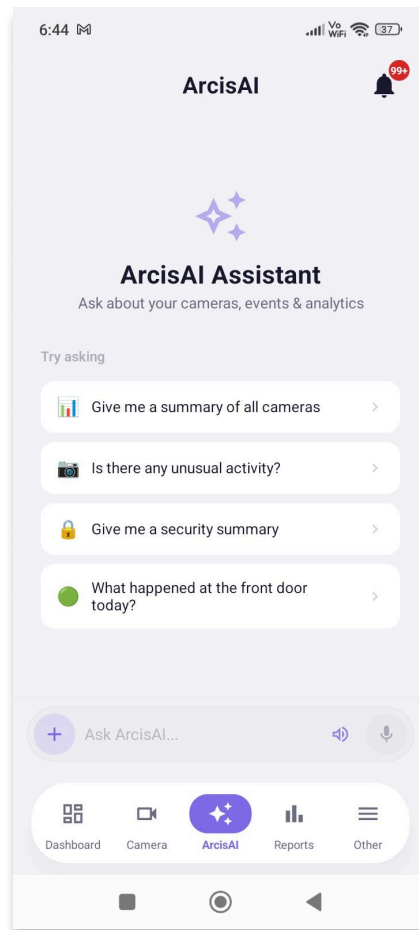

Reports

The Reports section gives you detailed analytics and insights from all your cameras. To open it, tap Reports on the bottom navigation bar.

Header

- **Reports Title:** Shown at the top centre.
- **Back Arrow (←):** Return to the previous screen.

Filters

Three dropdown filters are available at the top of the screen:

- **Date:** Select the date or date range for the report (for example, 2026-05).
- **All Devices:** Filter the report by a specific camera or view all devices.
- **All Events:** Filter the report by event type (for example, Human Detection, Motion).

View Options

On the right side, four icons let you switch between views:

- **Download Icon:** Download the report in PDF or Excel format.
- **Grid View:** Show event stats as cards.
- **List View (Event Log):** Show each event in a detailed list with preview.
- **Chart View:** Show events as charts and graphs.

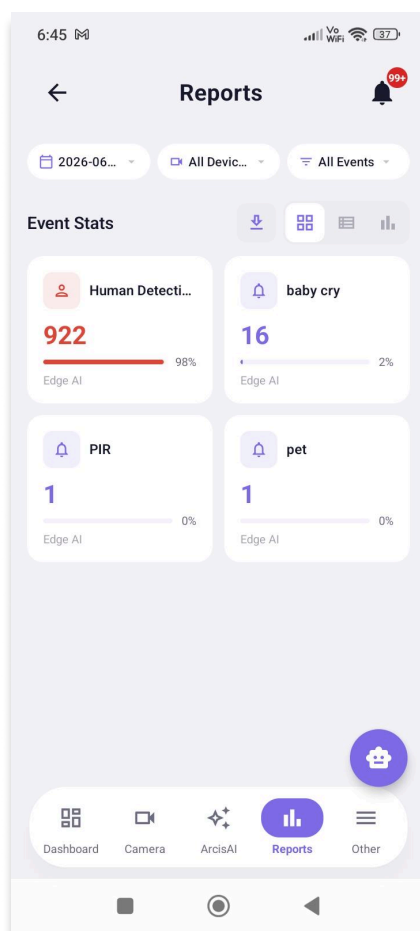

Reports

Grid View (Event Stats)

Tap the Grid View icon to see all events as individual cards.

Each card shows:

- **Event Name** (for example, Human Detection, PIR, baby cry, tamper_ipc, tamper_tf).
- **Total Count** of events for the selected date range.
- **Percentage Bar** showing how much this event contributes to the total.
- **Edge AI** label, showing the event was detected by the camera's built-in AI.

This view gives you a quick visual breakdown of all event types from your cameras.

List View (Event Log)

Tap the List View icon to see every event in a detailed log format.

Each event entry shows:

- **Event Name** (for example, Human Detection) with an edge tag.
- **Camera Name** (for example, ATPL-504298-AUGEN).
- **Time** when the event was detected.

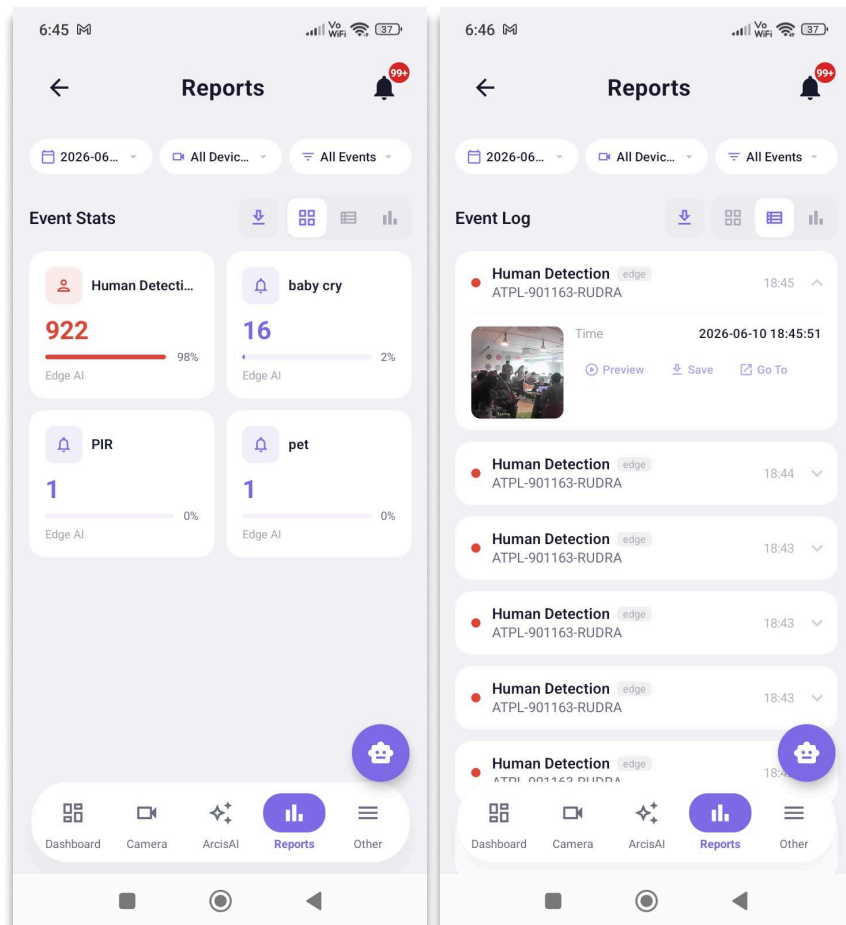

Reports

Tap any event to expand it and see more details:

- **Time:** The exact date and time of the event (for example, 2026-05-21 17:31:08).
- **Event Snapshot:** A thumbnail image captured at the time of the event.
- **Preview:** Tap to play a short video clip that is automatically generated for the detected event.
- **Save:** Download the event clip to your device.
- **Go To:** Open the camera live view directly from the event.
- The List View is useful when you want to review each event one by one with full details and proof.

Chart View (Weekly Stats)

Tap the Chart View icon to see weekly statistics in a visual format.

Total Events This Week

- Shows the total number of events recorded this week (for example, 1,993).
- A comparison label shows the difference from last week (for example, vs 0 last week, +0.0%).

Highlights

Three cards summarise the most important data:

- **Peak Hour:** The hour with the highest activity (for example, 16:00).
- **Top Camera:** The camera with the most events (for example, ATPL-504... with 1168 events).
- **Top Event Type:** The most detected event (for example, Human Detection with 1874 events).

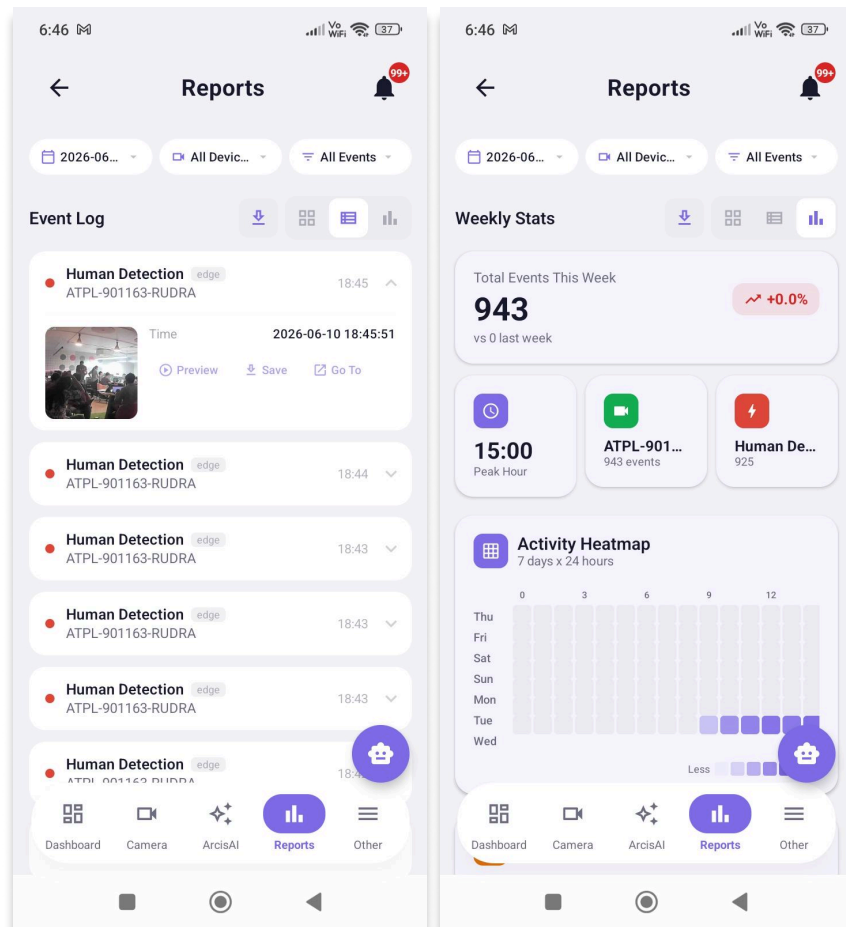

Reports

Activity Heatmap

A 7 days × 24 hours heatmap shows event activity across the week. Darker colours mean more activity at that time. Use it to spot patterns of activity by day and hour.

Event Breakdown and Top Cameras

Scroll down on the Chart View to see more analytics.

Event Breakdown

Shows the percentage and count of each event type recorded:

- Human Detection
- tamper_ipc
- PIR
- tamper_tf
- baby cry
- pet
- vehicle

Each event is shown with a coloured bar and its percentage of total events, so you can quickly see which events occur most often.

Top Cameras

Lists the top 3 cameras with the highest event count, ranked from highest to lowest. Each entry shows the camera name and the total event count.

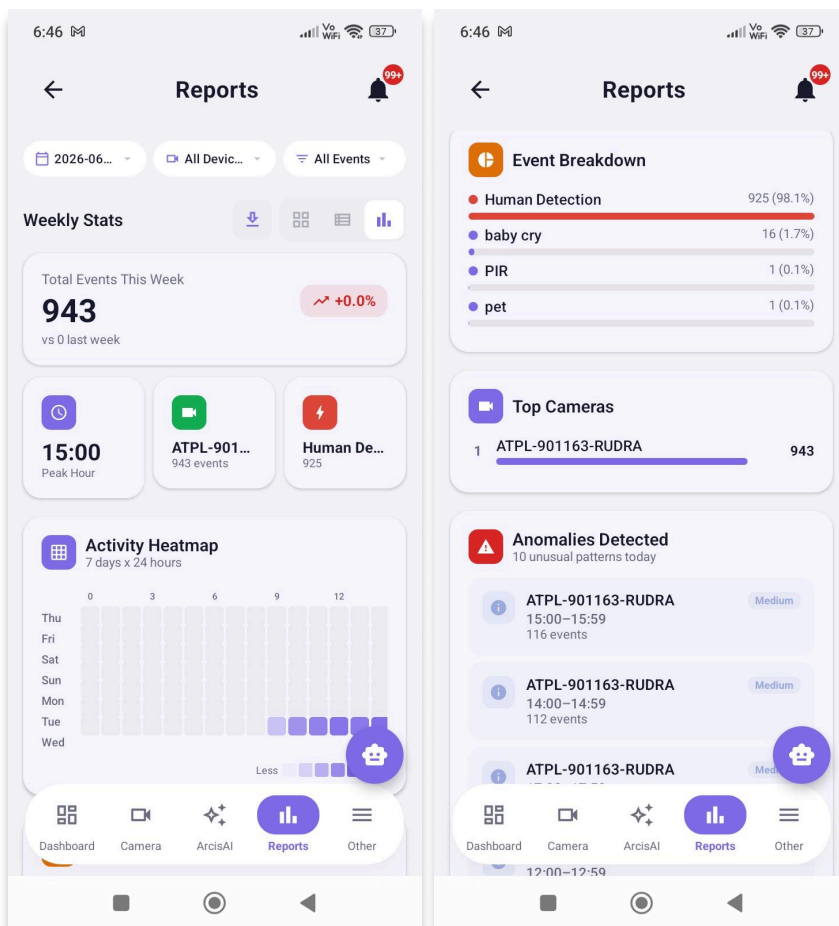

Reports

Anomalies Detected

The Anomalies Detected section shows unusual activity patterns picked up by ArcisAI across your cameras.

- The header shows the total number of anomalies for the day (for example, "9 unusual patterns today").
- Each anomaly card shows:
 - Camera Name (for example, ATPL-504298-AUGEN, Test).
 - Time Range when the anomaly happened (for example, 16:00–16:59).
 - Total Events Count in that period (for example, 134 events).
 - Severity Label (for example, Medium).

Use this section to quickly find and review unusual activities that may need your attention.

Downloading Reports

Tap the Download icon at the top-right of the Reports screen to export the report.

Users can export the generated report in the following formats:

- **PDF Format:** Suitable for easy viewing, printing, and sharing with teams or clients.
- **Excel Format:** Ideal for data analysis, custom filtering, and record-keeping.

Downloaded reports include timestamps, event types, device names, and supporting analytics where available.

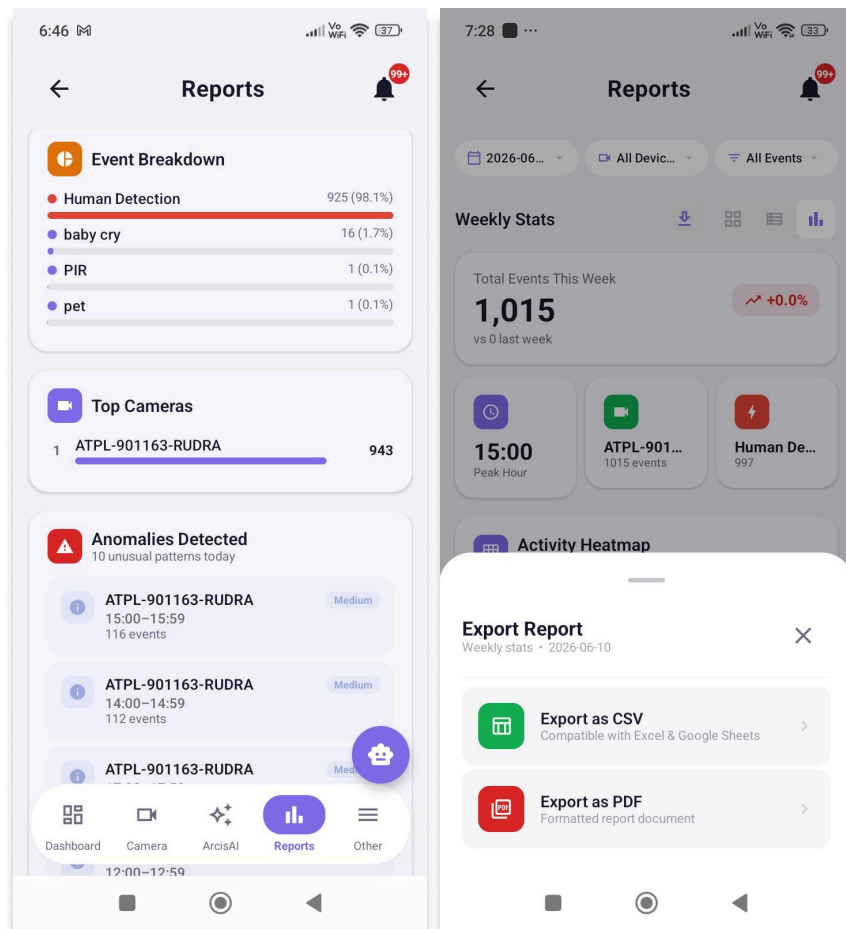

Other (Settings)

The Other section is your settings and account hub. To open it, tap Other on the bottom navigation bar.

Header

- **Other**: Shown at the top centre.

Profile Card

At the top of the screen, your profile card shows:

- **Profile Initial**: A circle with the first letter of your name.
- **Account Name**: Your registered name (for example, dalsaniya vasu).
- **Email Address**: Your registered email ID.
- **Edit Icon**: Tap to open the My Account popup and edit your details.
- **Delete Account**: Tap the Delete Account button to delete your ArcisAI account.

Settings Sections

The Settings screen is divided into four sections:

- **General**: Access to camera events.
- **Support**: Help and FAQs.
- **Appearance**: Theme and app tour options.
- **About**: Company info, policies, and warranties.

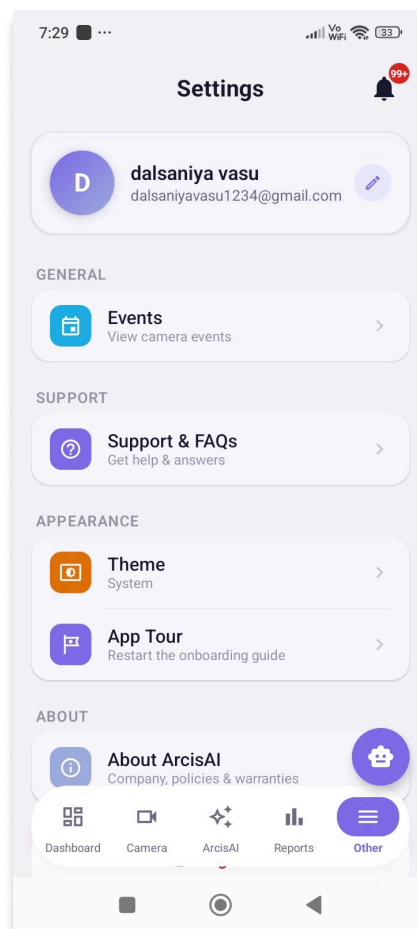

Other (Settings)

My Account

Tap the Edit icon on the profile card to open the My Account popup. From here, you can view and update your account details.

The popup shows:

- **Name:** Your registered name. Tap Edit on the right to change it.
- **Email:** Your registered email ID (cannot be changed).
- **Mobile:** Your registered mobile number. Tap Edit on the right to change it.

Tap the **X** icon at the top-right of the popup to close it.

Events

The Events section shows online-first cameras by default. To open it, tap Other → Events from the Settings screen.

Header

- **Events Title:** Shown at the top centre.
- **Back Arrow (←):** Return to the Settings screen.

Event Tabs

Two tabs are available at the top:

- **Edge Events:** Events detected by the camera's built-in AI (Edge AI).
- **Cloud Events:** Events processed and stored through cloud AI analytics.

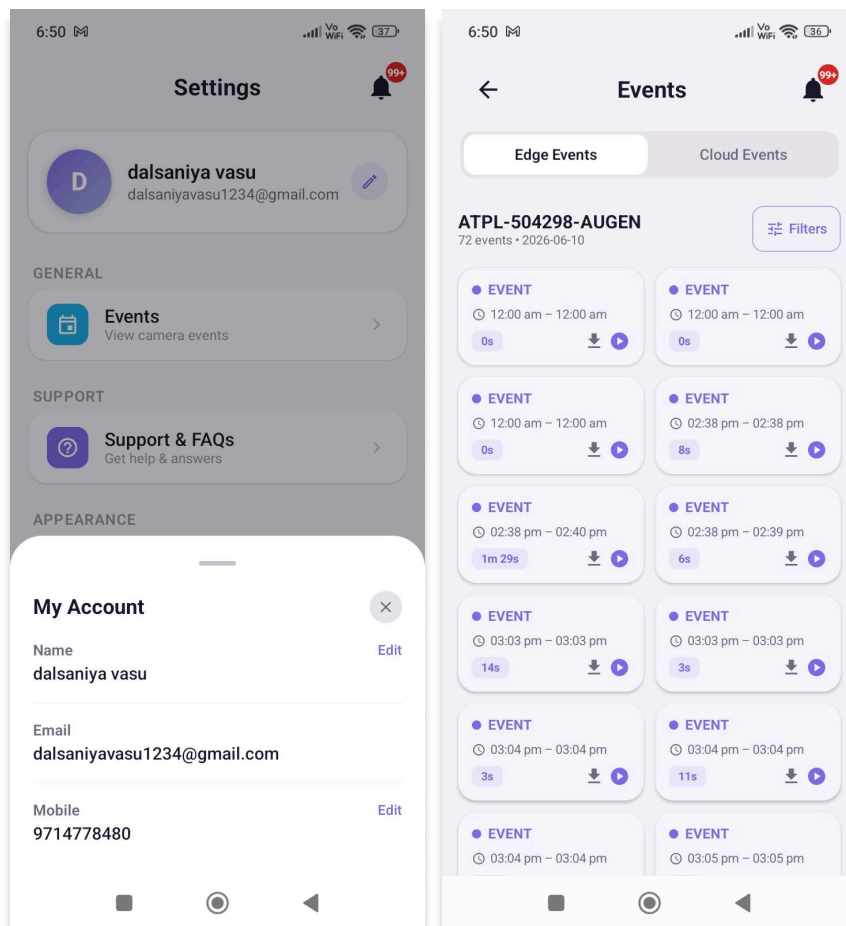

Other (Settings)

Event Summary

Below the tabs, a summary shows:

- **Camera Name** (for example, ATPL-504298-AUGEN).
- **Total Events Count** and **Date** (for example, 75 events • 2026-05-21).
- **Filters Button** on the right to refine the event list.

Event List

The Event List shows all events from the selected camera as cards in a grid view.

Each event card shows:

- **Event Label:** The event type (for example, EVENT).
- **Time Range:** The start and end time of the event (for example, 11:24 am – 11:27 am).
- **Duration:** The length of the event (for example, 3m 26s).
- **Download Icon (↓):** Save the event clip to your device.
- **Play Icon (>):** Tap to play the recorded event clip.

Tap any event card to open the event details popup and view the captured video.

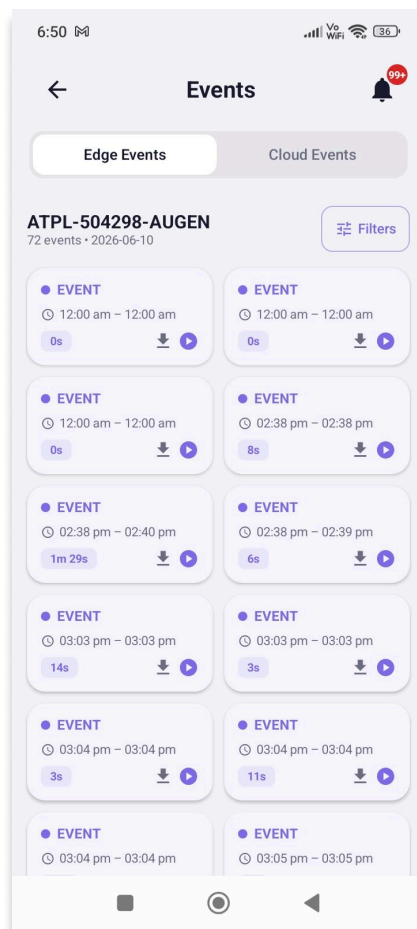

Other (Settings)

Filter Events

Tap the Filters button on the Events screen to open the Filter Events popup. Filters help you find specific events quickly.

Camera

Select a camera from the dropdown to view events from that camera only (The Events section shows online-first cameras by default.)

Date

Choose the date for which you want to view events (for example, 2026-05-21).

Event Types

Select one or more event types to filter the results. The available types are:

- Motion
- Human
- Tamper

Tap **Deselect all** on the right to clear your selection.

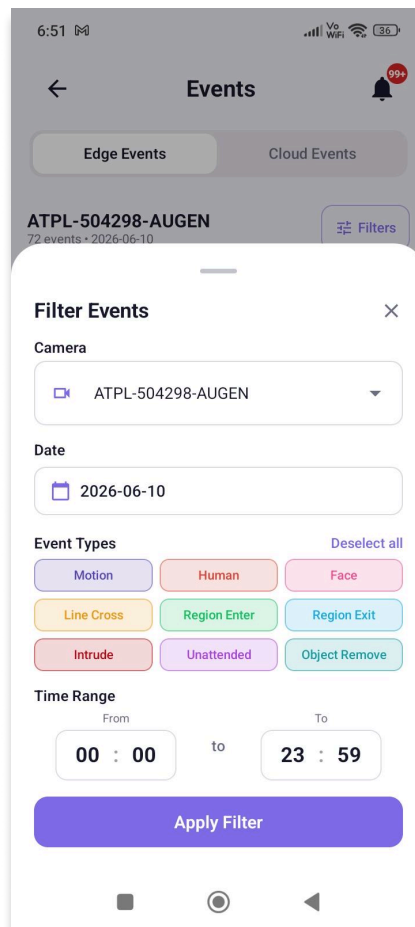

Other (Settings)

Time Range

Set the From and To time range to view events within a specific time period (for example, 00:00 to 23:59).

Apply Filter

After selecting your filters, tap the Apply Filter button at the bottom to update the event list.

Support & FAQs

The Help & Support section lets you find answers, browse FAQs, and raise a support ticket with our team. To open it, tap Other → Support & FAQs from the Settings screen.

Top Section

- A short message "Find answers or reach out to our team" is shown at the top.
- **+ New Ticket Button:** Tap to create a new support ticket.
- **Search Bar:** Type any keyword to quickly find help articles or FAQs.

Ticket Summary

- Four tiles show the status of your support tickets — Total, Open, Resolved, and Closed.

How Can We Help?

- Below the ticket summary, common help categories are shown as cards (for example, Camera Offline, Camera Quality, Recording & Playback, Cloud & Storage, and more). Tap any category to view related FAQs or start a new ticket for that issue.

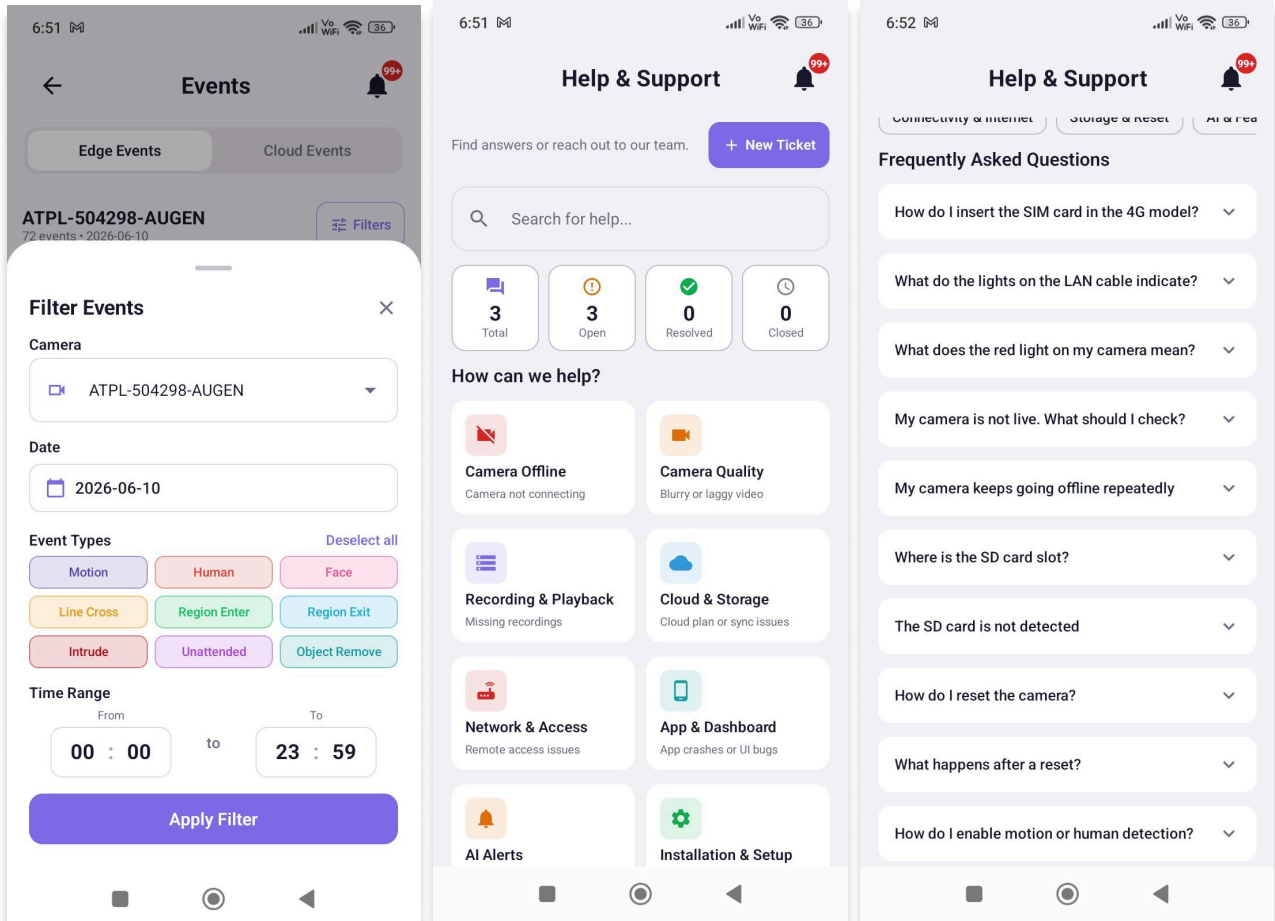

Other (Settings)

Frequently Asked Questions

When you tap a category, the FAQ section opens with sub-category filter chips at the top (for example, Connectivity & Internet, Storage & Reset, AI & Features, and more).

Below the filters, a list of common questions is shown (for example, "How do I insert the SIM card in the 4G model?", "My camera is not live. What should I check?", "How do I reset the camera?"). Tap any question to expand and see the answer.

Use the FAQs to quickly find answers without raising a support ticket.

Your Tickets

- Below the FAQ list, the Your Tickets section shows the list of tickets you have raised.

Ticket Filters

- Four filter chips help you sort tickets by status: All, Open, Resolved, Closed.

Ticket Card

Each ticket card shows:

- **Ticket ID** (for example, TKT-202605-00035).
- **Status Tag** (for example, New).
- **Short Description** of the issue.
- **Time Stamp** (for example, Just now).

Tap any ticket card to open the ticket details.

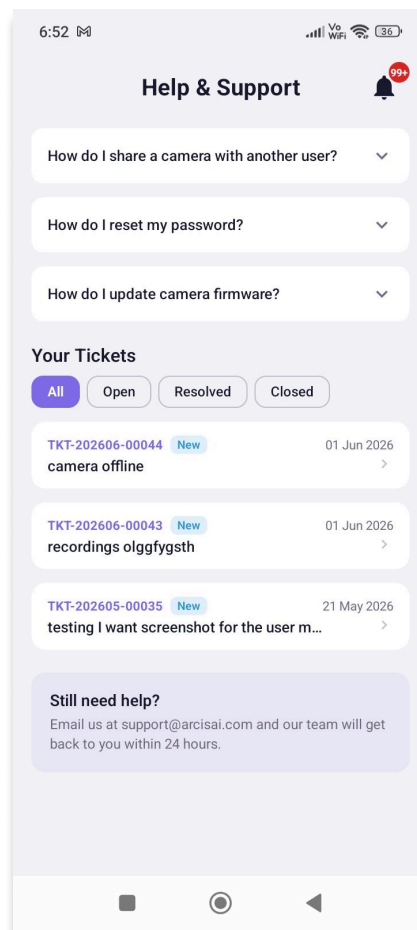

Other (Settings)

Still Need Help? —

At the bottom, the Still Need Help section is shown:

"Email us at contact@adiance.com and our team will get back to you as soon as Possible.

Create Support Ticket — Step 1: Category —

Tap the + New Ticket button on the Help & Support screen to start the ticket creation process. The ticket form has 4 simple steps.

The first step asks "What do you need help with?". Select the category that best matches your issue (for example, Camera Offline, Camera Quality, Recording & Playback, and more).

After selecting a category, tap Continue to move to the next step. Tap Cancel to close the ticket form.

Create Support Ticket — Step 2: Details —

In Step 2, provide more details about your issue.

- **What's the issue?** Type a short description of the problem in the text box (up to 200 characters).
- **More details (optional):** Add any extra details that may help our team understand the issue.
- **Which camera(s) are affected?** Tap the dropdown to select one or more cameras. A green dot → camera is online.

Selecting cameras helps the system run automatic diagnostics on those cameras.

Tap **Continue** to move to the next step or **Back** to go to the previous step.

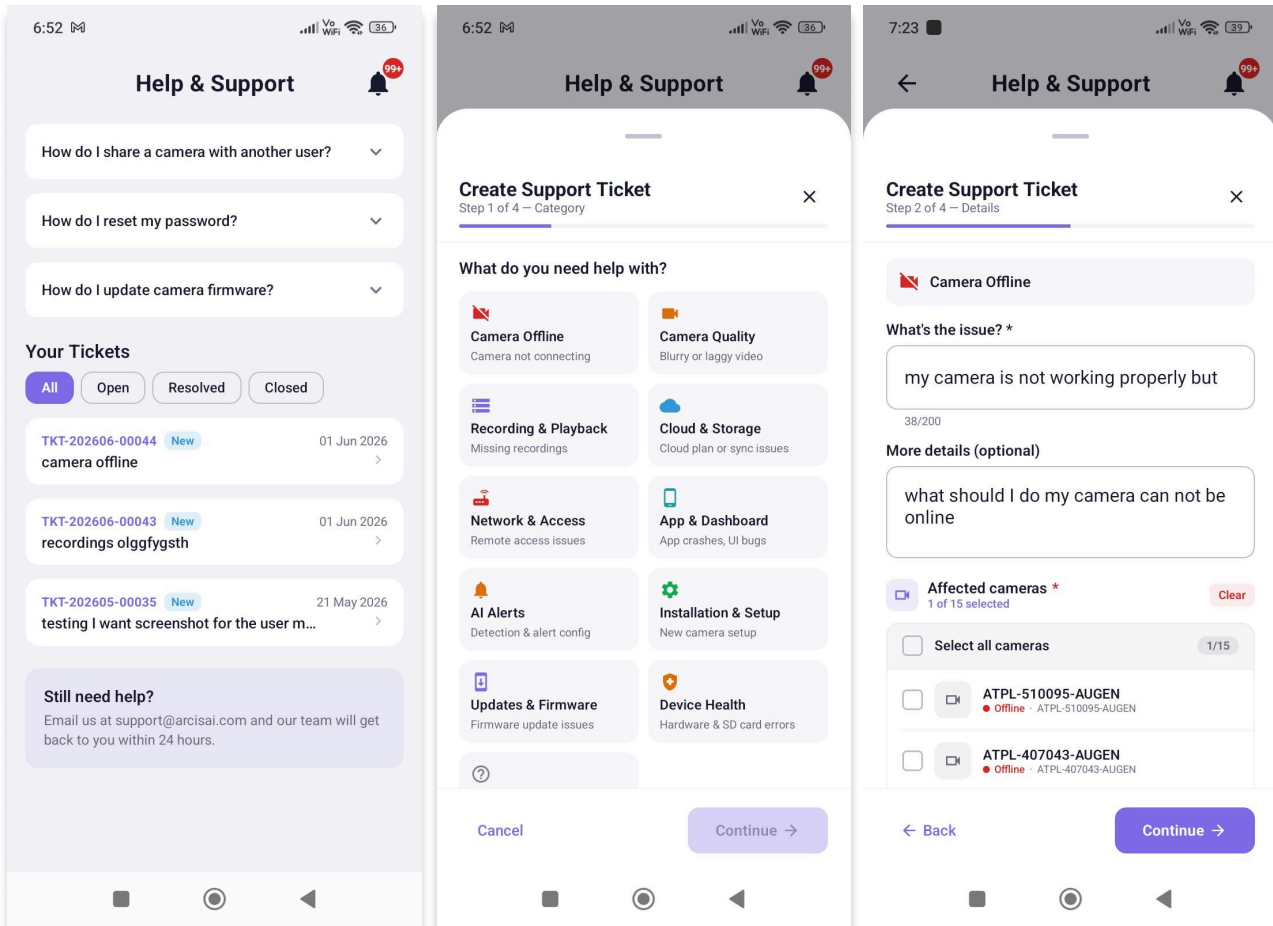

Other (Settings)

Create Support Ticket — Step 3: Questions

In Step 3, answer a few quick diagnostic questions. These help our team understand and solve your issue faster.

The questions depend on the selected category. For example, for Camera Quality:

- **Is the video blurry or clear?** — Blurry / Clear but laggy / Pixelated
- **Is the issue in live view, playback, or both?** — Live View / Playback / Both
- **Did you clean the camera lens recently?** — Yes / No
- **Is night vision working?** — Yes / No / Not Applicable

Select the correct answer for each question, then tap **Continue** to move to the next step.

Create Support Ticket — Step 4: Review

In Step 4, review all your ticket details before submitting.

The review screen shows:

- **Category:** The selected help category.
- **Issue:** Your short description of the problem.
- **Details:** Any extra details you added.
- **Cameras:** The selected camera(s).
- **Diagnostic Answers:** Your answers to the diagnostic questions.

A note is shown at the bottom: "Automatic diagnostics will run on selected cameras after submission."

Tap **Submit Ticket** to send your ticket to the support team. Tap **Back** to edit any step.

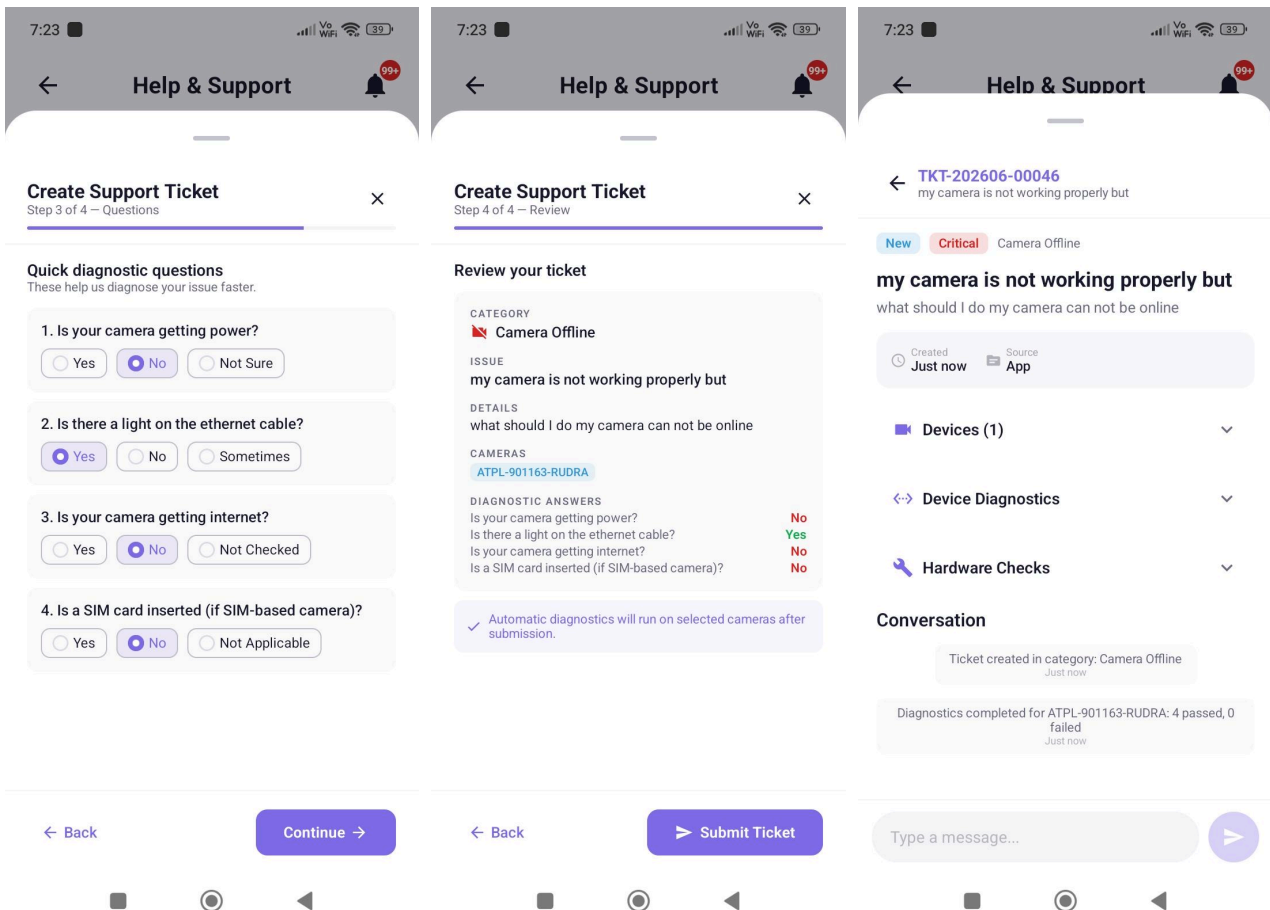

Other (Settings)

Ticket Details

After submitting, your ticket appears under Your Tickets. Tap any ticket to open its details.

Header

- **Ticket ID** (for example, TKT-202605-00035).
- **Short Description** of the issue.

Ticket Info

- **Status Tag** (for example, New).
- **Priority** (for example, High).
- **Category** (for example, Camera Quality).
- **Issue Title** and full description.
- **Created Time** and **Source** (for example, App).

Devices

Shows the camera(s) linked to the ticket. Tap to expand.

Device Diagnostics

Shows the automatic diagnostic results for the selected cameras. Tap to expand.

Hardware Checks

Shows the hardware health check results. Tap to expand.

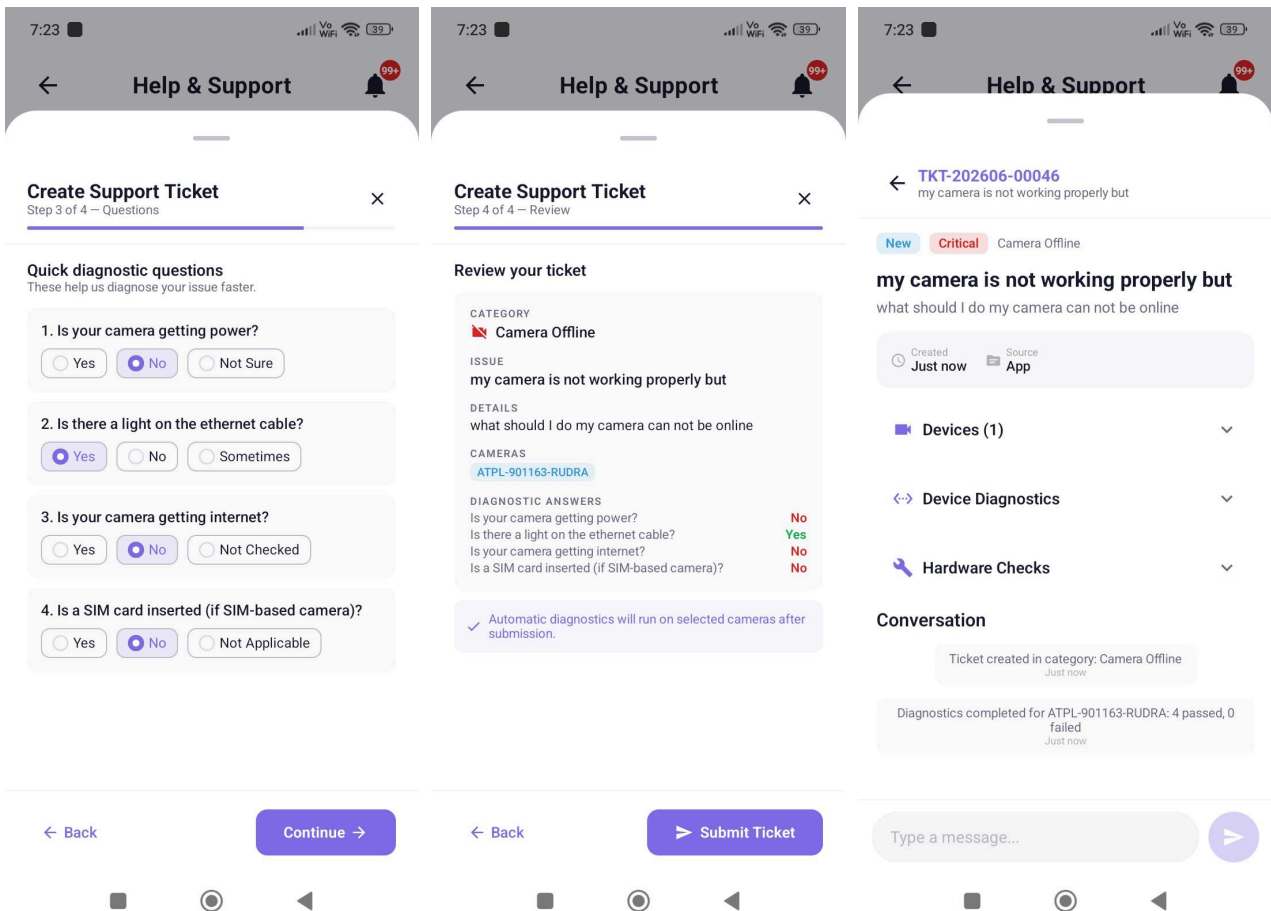

Other (Settings)

Conversation

Below all sections, a chat-style conversation log shows updates on your ticket, such as:

- Ticket created in category: Camera Quality.
- Diagnostics completed for the selected camera (for example, "4 passed, 0 failed").

Type a Message

At the bottom, a message bar lets you type and send a reply to the support team. Tap the **send icon** to send your message.

Appearance (Theme)

Tap **Theme** under the Appearance section to open the theme selection popup. From here, you can choose how the app looks.

Three theme options are available:

- **Light:** Always use the light appearance.
- **Dark:** Always use the dark appearance.
- **System:** Follows your device settings and switches automatically between light and dark.

Tap any option to apply it instantly.

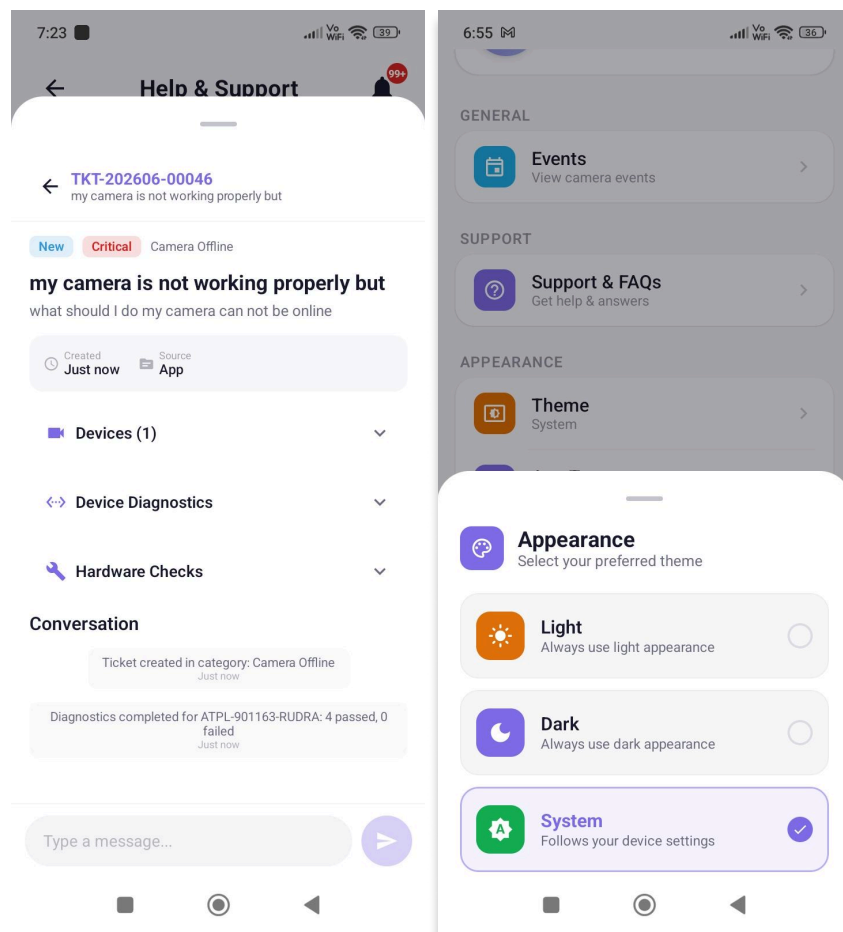

Other (Settings)

App Tour

Tap **App Tour** under the Appearance section to restart the onboarding guide. This is useful if you want to learn the app features again or refresh your understanding.

A welcome popup will appear with the message:

"Welcome to ArcisAI! Your intelligent surveillance platform. Let us walk you through every feature."

- Tap **Start Tour** to begin the step-by-step walkthrough of the app.
- Tap **Skip Tour** to close the popup and return to the Settings screen.

About ArcisAI

Tap **About ArcisAI** under the About section to view the company info, policies, and warranty details. The popup also shows the current app version (for example, Version 1.0.0).

The About ArcisAI popup has the following sections:

- **About Us:** Learn about ArcisAI and the company behind it.
- **Privacy Policy:** Read how your data is collected, used, and protected.
- **Terms of Service:** Read the terms and conditions for using the app.
- **Warranty Service:** View the warranty details for your ArcisAI cameras.
- **Warranty Policies:** Read the full warranty policies and coverage information.

Tap any section to expand it and read the full details. Tap the X icon at the top-right to close the popup.

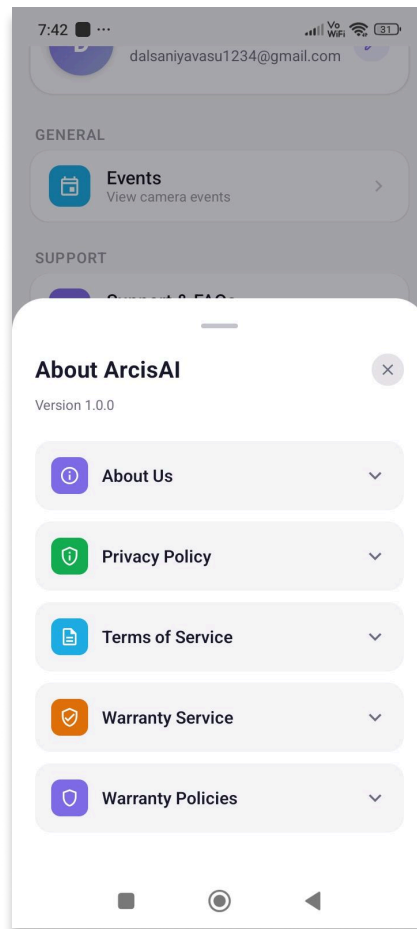
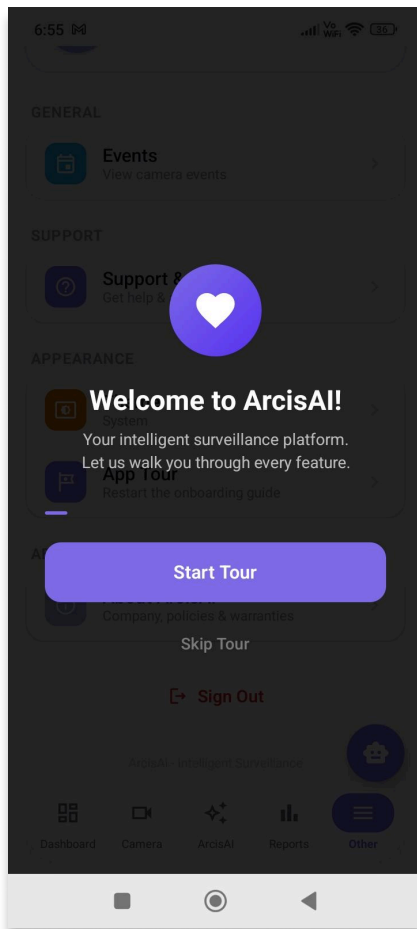

Other (Settings)

Sign Out

At the bottom of the Settings screen, the Sign Out option is shown in red.

- Tap **Sign Out** to log out from your ArcisAI account.
- After signing out, you will be redirected to the login screen.
- To use the app again, sign in with your registered email or mobile number and password.

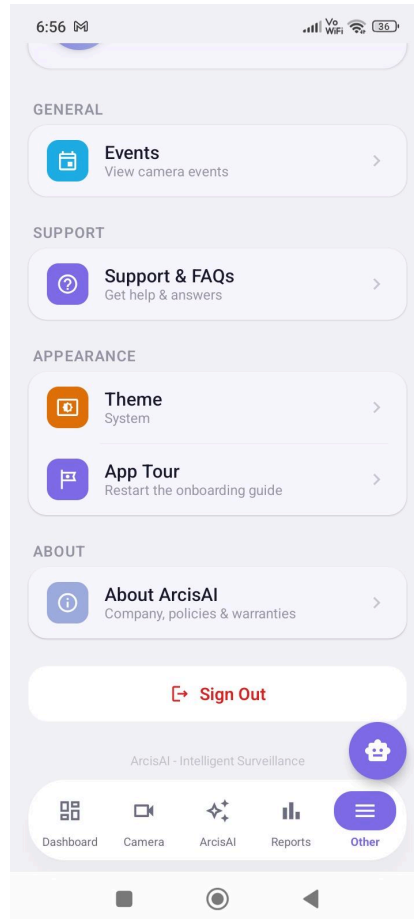

Support & Contact

For any technical assistance or camera-related queries, feel free to reach out to our support team:

Phone Support:

+91 9316728854

Email Support: contact@adiance.com

WhatsApp Support: Message us directly on WhatsApp at +91 9316728854

Our team is available to help you with camera setup, connectivity issues, AI configuration, and general troubleshooting.